



This supplement is not intended to replace your vehicle Owner's Manual, which contains more detailed information concerning the features of your vehicle as well as important safety warnings designed to help reduce the risk of injury to you and your passengers. Please read your entire Owner's Manual carefully as you begin learning about your new vehicle and refer to the appropriate sections when questions arise.

All information contained in this supplement was accurate at the time of publication. We reserve the right to change features, operation and/or functionality of any vehicle specification at any time. Your Ford dealer is the best source for the most current information. For detailed operating and safety information, please consult your Owner's Manual.



FORD PERFORMANCE



August 2019
First Printing
Litho in USA



LR3J19A285 LAA



owner.ford.com (U.S.)



ford.ca (Canada)



2020 SHELBY GT500®
MUSTANG SUPPLEMENT

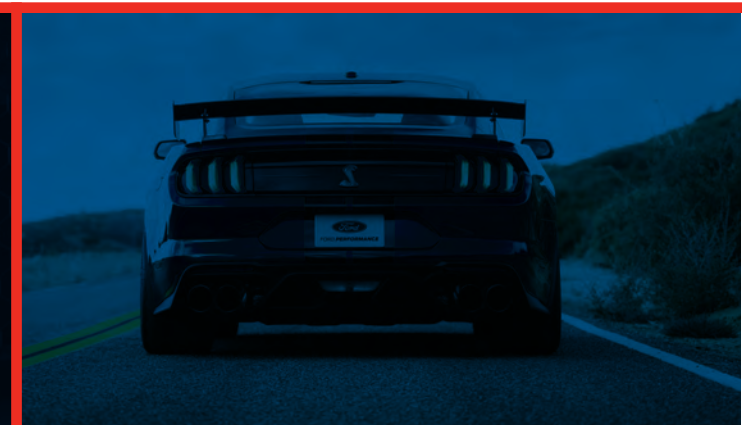

The information contained in this publication was correct at the time of going to print. In the interest of continuous development, we reserve the right to change specifications, design or equipment at any time without notice or obligation. No part of this publication may be reproduced, transmitted, stored in a retrieval system or translated into any language in any form by any means without our written permission. Errors and omissions excepted.

© Ford Motor Company 2019

All rights reserved.

Part Number: 20190708130802

Table of Contents

Introduction

About This Supplement3

At a Glance

At a Glance6

Child Safety

Installing Child Restraints8

Steering Wheel

Audio Control10

Voice Control10

Information Display Control10

Drive Mode Control11

Instrument Cluster

Gauges12

Information Displays

General Information13

Fuel and Refueling

Fuel Quality16

Transmission

Automatic Transmission17

Technical Specifications23

Brakes

General Information24

Electric Parking Brake24

Stability Control

Using Stability Control26

Driving Aids

Drive Control27

Towing

Towing a Trailer30

Transporting the Vehicle30

Towing the Vehicle on Four Wheels33

Driving Hints

Breaking-In35

Driving Through Water35

Roadside Emergencies

Towing Points36

Fuses

Fuse Specification Chart37

Maintenance

Opening and Closing the Hood38

Under Hood Overview39

Engine Oil Check39

Changing the Engine Oil and Oil Filter
.....40

Engine Coolant Check41

Changing the Engine Air Filter43

Track Use

Track Use44

Vehicle Care

General Information55

Cleaning the Exterior56

Wheels and Tires

Wheels57

Tires58

Using Winter Tires60

Capacities and Specifications

Engine Specifications61

Table of Contents

Brake System Specifications62
Suspension Specifications63
Motorcraft Parts64
Capacities and Specifications65

Warranty Terms and Conditions

Base Warranty70

Scheduled Maintenance

General Maintenance Information71
Normal Scheduled Maintenance74
Special Operating Conditions Scheduled Maintenance77
Scheduled Maintenance Record80

Introduction

ABOUT THIS SUPPLEMENT

Congratulations on your decision to purchase or lease the latest from Ford Performance. If you have owned or leased a Ford Performance product in the past, we are glad you are back. If this is your first

Ford Performance vehicle, welcome to the Ford Performance family! We are confident that our dedication to performance, quality, craftsmanship and customer service will provide many miles of exhilarating, safe and comfortable driving in your new vehicle.



Your choice of a Ford Performance product is an intelligent and informed one. Ford Performance strives to build engaging vehicles that involve the driver in every aspect of the driving experience. Although performance is at the heart of every Ford Performance vehicle, we go much further. Our goal is to deliver a comprehensive, complete vehicle, sweating the details such as the sound of the exhaust, the quality of the interior materials, and the functionality and the comfort of the seats, to make sure that the driver enjoys not only exceptional performance, but an

outstanding driving environment as well. In your Ford Performance vehicle, that philosophy is expressed by a sophisticated powertrain, outstanding chassis dynamics and significant interior and exterior enhancements.

This supplement complements your Mustang Owner's Manual and provides information specific to your Ford Performance vehicle. By referring to the pages listed in this supplement, you can identify those features, recommendations

Introduction

and specifications unique to your new vehicle. If there are any discrepancies between this supplement and the Mustang Owner's Manual, this supplement shall supersede the information found in the Mustang Owner's Manual.

If you have any questions or concerns regarding your Ford Performance vehicle, please call the Ford Performance Info Center at 1-800-367-3788.

SVT History

The Ford Special Vehicle Team (SVT) was established in 1991 to polish the Ford Oval by creating low-volume, factory-produced vehicles designed for those select few whose idea of driving is a high-powered, passionate experience – not just a means of getting from point A to point B.

In a move to support this spirited enthusiasm, Ford Motor Company carefully integrated the wide array of talent in the company into a small, cross-functional group of engineers and product planners, housed together under one roof with a common mission: to create vehicles specifically designed to meet the unique needs and desires of the knowledgeable driving enthusiast.

More than 400,000 SVT and Ford Performance vehicles were produced since the 1993 model year. These include the SVT Mustang Cobra and the Cobra R, the SVT F-150 Lightning, the SVT Contour, the SVT Focus, Ford GT, Shelby GT500, GT500KR and the F-150 SVT Raptor.

Team RS History

TeamRS traces its roots back nearly 60 years from the Lotus Ford Cortina and Twin Cam Escorts of the mid 1960's, through the first RS branded Escorts of the 1970's to the founding of Special Vehicle Engineering (SVE) in 1980. Through the

1980s and 90s, SVE delivered a breadth of vehicles from exciting XR and RS branded road going performance cars through homologation specials such as the iconic Sierra Cosworth RS500. The first ST (Sport Technology) vehicle appeared in 1996 as the ST24 Mondeo. The first collaboration between Ford's European and North American performance teams appeared in 2002 as the ST170 in Europe and SVT Focus in North America. In 2003, TeamRS replaced SVE in Europe as performance car and motorsport personnel were brought together as one team. TeamRS subsequently created the 2004 Fiesta ST, 2005 Focus ST and 2009 Focus RS.

Ford Performance

SVT and Team RS officially began working together as one team in 2009. In 2015, these two teams, along with Ford Racing, were formally combined establishing Ford Performance as a single team responsible for all performance and racing oriented products and activities worldwide at Ford Motor Company. Your Ford Performance vehicle represents the best of what Ford Performance has to offer from around the globe. Your vehicle has been designed and developed with the four hallmarks of Ford Performance in mind: Performance, Substance, Exclusivity and Value. We are proud and passionate about what we do, and we are glad you have made us your choice.

Included in the purchase price of your Ford Performance vehicle is a one day class at the Ford Performance racing school. For additional information, refer to www.fordperformanceracingschool.com.

Introduction



At a Glance



Powertrain

- 5.2L Supercharged engine.
- Tremec TR-9070-DCT 7-speed dual wet clutch transmission.
- 2.65L inverted supercharger.
- 3.73 Torsen differential.
- Large bore electronic throttle body.
- Cold air intake and filter.
- Tubular exhaust manifolds.
- High flow dual 2.75 in (6.98 cm) exhaust with X-pipe and valved mufflers.
- Dual mass flywheel.
- Transmission, differential and engine oil coolers.

Chassis

- Electric power assisted steering.
- 6-piston front, 4-piston rear Brembo calipers, and front cooling ducts.
- 16.5 in (420 mm) front and 14.6 in (370 mm) rear rotor diameters.
- Two-piece front and rear rotors.
- Electric Parking brake.
- MagneRide dampers and sensors.
- Lightweight magnesium tower to tower brace.
- Adjustable camber front strut top mounts (if equipped).

Exterior

- Unique aero (splitter, grilles, underbody shield, diffuser).
- Aluminum front bumper.
- Flow formed aluminum wheels.

At a Glance

- Carbon fiber wheels (Carbon fiber track pack).
- Michelin PS4S tires.
- Michelin Pilot Sport Cup 2 tires (Carbon fiber track pack).
- Handling package with spoiler Gurney and front wickers (if equipped).
- Aerodynamic adjustable rear wing, adjustable front strut top mounts, front wickers (if equipped).
- Removable rain tray.
- Painted or vinyl over the top stripes (if equipped).
- Optional vinyl side stripes (not available with painted over the top stripes).
- Front recovery hook.

Interior

- SYNC 3 (8 inch screen).
- Navigation (if equipped).
- 12 inch digital instrument cluster.
- Drive Mode Control (Normal, Sport, Track, Drag Strip, Slippery).
- Performance Shift Indicator.
- Unique instrument panel and gauges.
- 12-speaker B&O™ Sound System by Bang & Olufsen with CD Player, HD Radio™ and Subwoofer in-trunk (if equipped).
- Dual zone electronic climate control.
- Leather and micro suede Recaro seats (if equipped).
- 6-way power climate controlled leather seats (if equipped).
- Rear seat delete (Carbon fiber track pack).
- Unique steering wheel with magnesium paddle shifters.

Child Safety

INSTALLING CHILD RESTRAINTS

Rear Seat Delete (If Equipped)



WARNING: It is extremely dangerous to ride in a cargo area, inside or outside of a vehicle. In a crash, people riding in these areas are more likely to be seriously injured or killed. Do not allow people to ride in any area of your vehicle that is not equipped with seats and seatbelts. Make sure everyone in your vehicle is in a seat and properly using a seatbelt. Failure to follow this warning could result in serious personal injury or death.

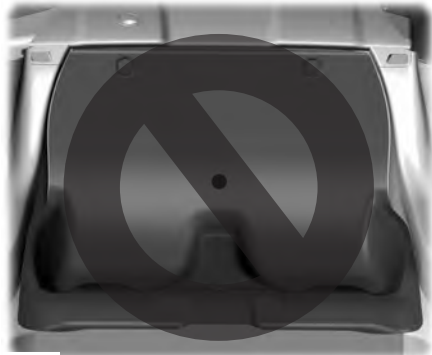

E216990

This is not a seating position. You cannot place persons or child restraints in the rear of the vehicle with the rear seat delete option.

Vehicles Without Rear Seats

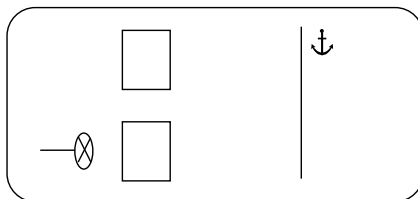

E216824

Once you have installed the child restraint using the seatbelt, you can attach the top tether strap.

Attach the tether strap only to the appropriate tether anchor as shown. The tether strap may not work properly if you attach it somewhere other than the correct tether anchor.

Perform the following to attach a child restraint to the tether anchor.

Route the tether strap as follows.



E216991

For coupe without rear seats, route the tether strap through the inboard slot of the front passenger seat backrest or route the tether strap over the top of the seat. You may need a tether strap extension to reach the tether anchor.

Child Safety

If you install a child restraint and you attach the top tether strap to the proper top tether anchor, do not tighten the tether strap enough to lift the child restraint off the vehicle seat cushion when the child is seated in it. Keep the tether strap just snug without lifting the front of the child restraint. Keeping the child restraint just touching the vehicle seat gives the best protection in a severe crash.

See the Child Safety chapter in your base Owner's Manual for more information.



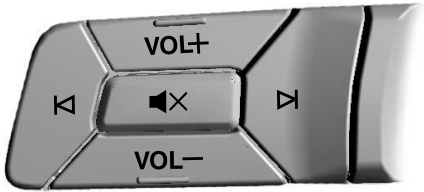

Steering Wheel

AUDIO CONTROL



E286906

You can operate the following functions with the control:

-  Press - to decrease volume level.
Press + to increase volume level.
-  Press to silence the current media
-  Press to access the previous media selection.
-  Press to access the next media selection.

VOICE CONTROL

The controls are on the steering wheel.

-  Press and release to activate voice recognition.

INFORMATION DISPLAY CONTROL

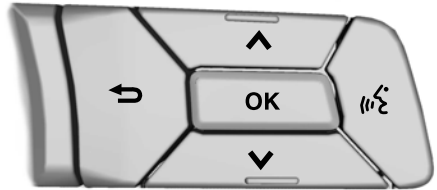

E248474

Quick Action Menus



See **Information Displays** (page 13).

Steering Wheel

DRIVE MODE CONTROL



E293836

See **Drive Control** (page 27).

Instrument Cluster

GAUGES

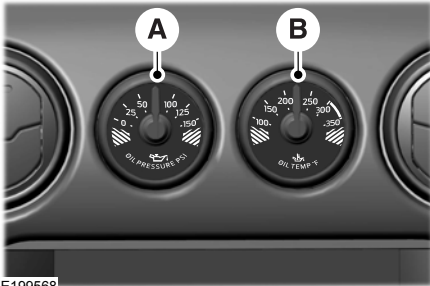

E199568

- A Oil pressure gauge - Indicates the engine oil pressure.
- B Oil temperature gauge - Indicates the engine oil temperature.

Information Displays

GENERAL INFORMATION



WARNING: *Track Apps™* is for track use only. Remember that even advanced technology cannot defy the

laws of physics. It is always possible to lose control of a vehicle due to inappropriate driver input for the conditions. Aggressive driving on any road condition can cause you to lose control of your vehicle increasing the risk of personal injury or property damage.

Note: *Track Apps™* provides a suite of options to record and optimize your track performances. See **Track Use** (page 44).

Cobra			
MyMode	Show Status		
	Add MyMode	MyMode must be configured and saved before selection enabled.	
Track Apps	Line Lock		
	Launch Control	RPM	
	Acceleration Timer	Choose your applicable setting	
	Brake Performance		
	Lap Timer		
	Start Option		
Performance Shift Indicator	Shift Point	Choose your applicable setting	
	Shift Tone		
	Shift Light Mode		
	Shift Light Intensity		
	Display Source		
Gauges	Show Gauges	Choose your applicable setting	
	Configure MyGauges		
Exhaust Mode	Choose your applicable setting ¹		
	Quiet Start		
Cluster Appearance	Change with Drive Mode		
	Normal		

Information Displays

Cobra		
	Sport	
	Track	
MyColor	Primary Color	Choose your applicable setting
	Secondary Color	
	Create MyColor	

¹ See **Track Use** (page 44).

Note: **Quiet Start** allows you to schedule when the **Exhaust Mode** turns on the **Quiet** setting. The time window can be from 1 to 24 hours.

Configure MyGauges

When configuring your gauges you can select to display up to three virtual gauges.

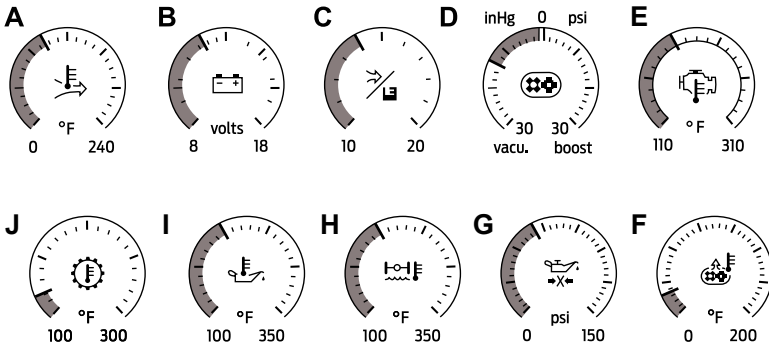

- A Inlet air temperature
- B Battery voltage
- C Air/fuel ratio
- D Vacuum/boost
- E Cylinder head temperature
- F Manifold charge temperature
- G Engine oil pressure
- H Axle temperature

Information Displays

- I Engine oil temperature
- J Transmission oil temperature

Fuel and Refueling

FUEL QUALITY

Choosing the Right Fuel

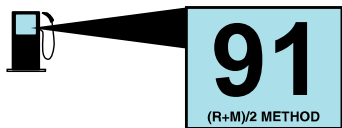

E185193

Use only premium unleaded gasoline with a minimum pump (R+M)/2 octane rating of 91. For optimal performance, use premium unleaded gasoline with an octane rating of 93 or higher.

The use of the correct fuel is an important part of the proper maintenance of your vehicle, and a condition of the vehicle Warranty. For this vehicle, the use of gasoline with an octane level of 91 or higher is required. The use of gasoline with an octane rating lower than 91 will invalidate the vehicle Warranty. It can degrade vehicle performance and lead to severe mechanical damage.

Do not be concerned if the engine sometimes knocks lightly. However, if the engine knocks heavily while using fuel with the recommended octane rating, contact an authorized dealer to prevent any engine damage.

We recommend Top Tier detergent gasolines, where available to help minimize engine deposits and maintain optimal vehicle and engine performance. For additional information, refer to www.toptiergas.com.

Note: *Use of any fuel other than those recommended can impair the emission control system and cause a loss of vehicle performance.*

Do not use:

- Diesel fuel.
- Fuels containing kerosene or paraffin.
- Fuel containing more than 15% ethanol or E85 fuel.
- Fuels containing methanol.
- Fuels containing metallic-based additives, including manganese-based compounds.
- Fuels containing the octane booster additive, methylcyclopentadienyl manganese tricarbonyl (MMT).
- Leaded fuel, using leaded fuel is prohibited by law.

The use of fuels with metallic compounds such as methylcyclopentadienyl manganese tricarbonyl (commonly known as MMT), which is a manganese-based fuel additive, will impair engine performance and affect the emission control system.

Transmission

AUTOMATIC TRANSMISSION



WARNING: Always fully apply the parking brake and make sure you shift into park (P). Failure to follow this instruction could result in personal injury or death.



WARNING: Do not apply the brake pedal and accelerator pedal simultaneously. Applying both pedals simultaneously for more than a few seconds will limit engine performance, which may result in difficulty maintaining speed in traffic and could lead to serious injury.



WARNING: When your vehicle is stationary, keep the brake pedal fully pressed when shifting gears. Failure to follow this instruction could result in personal injury, death or property damage.

Note: You may not be able to shift out of park (P) unless the intelligent access key is inside your vehicle.

Note: Unlike the typical automatic transmission that has a torque converter coupling the engine to the transmission, this vehicle has a dual clutch transmission, which couples the engine to the transmission with two clutches in a similar fashion as a standard manual transmission.

Understanding the Positions of Your Rotary Shift Transmission



- P Park.
- R Reverse.
- N Neutral.
- D Drive.
- M Manual.

Your vehicle has an electronic transmission shifter. The transmission selector is on the center console.

The instrument cluster displays the current drive range.

Park (P)

With the transmission in park (P), your vehicle locks the transmission and prevents the wheels from turning. Always come to a complete stop before putting your vehicle into and out of park (P).

When you switch the ignition off, your vehicle shifts into park (P). If you switch the ignition off when the vehicle is moving, the transmission first shifts into neutral (N) until it reaches approximately 3 mph (5 km/h) or slower, then shifts into park (P).

Transmission

The electric parking brake may apply when you shift to park (P) without the brake pedal fully pressed. The electric parking brake applies when you shift to park (P) on large slopes. The electric parking brake releases with the drive away release function, or if you manually release it. See **Electric Parking Brake** (page 24).

Note: *A warning tone sounds if you open the driver door and you have not shifted the transmission selector to park (P).*

Automatic Return to Park

Your vehicle has a feature that shifts into park (P) when any of the following conditions occur and your vehicle is stationary:

- You switch the vehicle off.
- You open the driver door with your seatbelt unlatched.
- You unlatch the driver seatbelt when the driver door is open.

If you turn your vehicle off when moving, your vehicle first shifts into neutral (N) until it slows down enough to shift into park (P) automatically.

Note: *This feature does not operate when your vehicle is in Stay in Neutral mode.*

Note: *This feature may not work properly if the door ajar switch is malfunctioning. If your door ajar indicator does not illuminate when you open the driver door, the indicator illuminates with the driver door closed or a Transmission not in Park cluster message appears with the transmission in gear and the driver door closed, see your authorized dealer.*

Note: *If you have waited an extended period of time, 2-15 minutes before starting your vehicle, unlatching your seatbelt can cause this feature to activate, even with the driver door closed.*

Reverse (R)

With the transmission selector in reverse (R), your vehicle moves backward. Always come to a complete stop before shifting into and out of reverse (R).



WARNING: Move the transmission selector lever to reverse (R) only when your vehicle is stationary and the engine is at idle speed.

Neutral (N)

With the transmission selector in neutral (N), you can start your vehicle and it is free to roll. Hold the brake pedal down when in this position.



WARNING: In neutral (N) your vehicle has the ability to roll freely. If you intend to leave your vehicle, make sure you apply the parking brake.

Stay in Neutral Mode

Note: *Do not use Stay In Neutral Mode for towing as the transmission shifts to park (P) if the battery voltage becomes low.*

Note: *Stay in Neutral Mode is a temporary vehicle state that works with the engine being in the running or OFF state. Extended usage of Stay in Neutral Mode when the engine is OFF may result in a battery voltage reduction to the level where the vehicle may no longer start. Failure to follow this instruction could result in vehicle damage not covered by the vehicle warranty.*

When in Stay in Neutral Mode, you can start your vehicle and it is free to roll.

To enter Stay in Neutral Mode, do the following:

1. Bring your vehicle to a complete stop.
2. Shift into neutral (N).

Transmission

- Press the manual (M) button within 5 seconds after shifting to Neutral.

Note: *A Stay in Neutral Mode confirmation message appears in the information display when your vehicle has entered Stay in Neutral Mode and the neutral (N) button on the transmission selector slowly blinks.*

To exit Stay in Neutral Mode, press the brake pedal and shift to park (P) or start the engine and apply brakes to shift to another gear, for example drive (D) or reverse (R).

Drive (D)

Drive (D) is the normal driving position for the best fuel economy and smoothness. Shift the transmission selector to drive (D) to allow your vehicle to move forward and shift automatically through the forward gears.

The transmission shifts to the appropriate gear for optimum performance based on ambient temperature, road slope, vehicle load and your input.

Manual (M)

To select manual (M), place the transmission selector in drive (D) and press the M button in the middle of the selector.

With the transmission selector in manual (M), the driver can change gears up or down using the paddle shifters. After pressing the manual (M) button while the transmission is in drive (D), you now have control of selecting the gear you desire using the (+) and (-) paddle shifters to upshift and downshift.

To exit manual (M) and return to drive (D), press the M button again.

SelectShift™ Dual Clutch Transmission

Your vehicle has a SelectShift Dual Clutch transmission. The SelectShift Dual Clutch transmission gives you the ability to change gears up or down without a clutch as desired.

Selectshift is operational in both drive (D), known as Live in Drive, and manual (M).

While the vehicle can be started as low as -22°F (-30°C), the transmission does not shift from park (P) until the transmission fluid temperatures warms up above -4°F (-20°C).

If the transmission is overheating from extreme use, it can result in the following symptoms.

Clutch Over Temperature: This message indicates one or both clutches are overheating and may open to protect the system. This occurs when the clutch absorbs too much energy in the form of slip, due to a variety of reasons.

Some examples of what could cause this are:

- Launch control at an RPM set speed higher than optimal for the current conditions. The best mitigation is to either lower the RPM set speed for launch control maneuvers, or not holding the RPM set speed as long in preparation for launch control.
- Slow uphill driving with no throttle application, known as creeping, or using the throttle instead of the brake to prevent rolling back on an uphill grade. These maneuvers cause the clutches to be in a constant state of slip. The best mitigation is to use the brake when at a standstill, or find a safe place to stop and put the transmission in park (P) until you can achieve a faster uphill speed of approximately 10 mph (16 km/h).

Transmission

If the clutch opens for temperature mitigation, clutch capability should be restored automatically after a brief period of time. If drive capability is not restored momentarily, stop in a safe location and shut the vehicle off for 5-10 minutes. If there are still transmission issues after shutting the vehicle off, contact your authorized dealer.

Transmission Too Hot Press Brake: This message acts as a warning that the transmission fluid is beginning to overheat. When a yellow warning appears in the cluster, you may notice a decrease in performance as engine torque limits itself to help cool the transmission fluid. Maximum torque limitation is indicated by a red warning. The best way to quickly cool the transmission fluid and restore full performance is non-aggressive driving at a constant speed between 40–70 mph (65–112 km/h) in the highest available gear.

Selectshift in Drive (D)

Provides a temporary manual mode for performing more demanding maneuvers where extra control of gear selection is beneficial. For example, when towing or passing another vehicle. This mode holds a selected gear for a temporary period of time depending on driver inputs like accelerator pedal travel and the steering wheel angle.

To prevent the engine from either running at too low an RPM which risks stalling, or at too high an RPM which risks engine damage, Live in Drive automatically downshifts and upshifts if the engine speed is approaching idle or redline and you have not shifted in time. Although Live in Drive makes some shifts for you, it still allows you to shift at any time if it determines that there is no risk of damage to the engine from lugging or over-revving.

- Pull and release (tap) the right paddle to (+) to upshift.
- Pull and release (tap) the left paddle (-) to downshift.
- Pull and hold both the right paddle (+) and the left paddle (-) to temporarily open the clutches. The transmission remains in neutral (N) until you release both paddles. When the clutches are open, no engine power transmits to the wheels and the vehicle can roll freely unless you apply the brakes.
- Pull and hold the right paddle (+) to exit Live in Drive and command the transmission to sequentially upshift to the maximum allowed gear.
- Pull and hold the left paddle (-) for the lowest allowable gear. This is only available in **Normal** and **Sport** drive modes.

Note: *Paddle icons appear next to current indicated gear when in Live in Drive.*



Note: *When in Live in Drive and you quickly press the accelerator pedal all the way down, the transmission downshifts for maximum performance when in drive (D).*

Transmission

SelectShift in Manual (M)

- Provides a permanent manual gear selection where full control of gear selection is required. Manual does not automatically upshift even if the engine is approaching the RPM limit. It must be shifted manually by pressing the (+) button
- Pull and release (tap) the right paddle (+) to upshift.
- Pull and release (tap) the left paddle (-) to downshift
- Pull and hold both the right paddle (+) and the left paddle (-) for a temporary neutral position. Neutral (N) remains until you release both paddles.
- Pull and hold the right paddle (+) to command the transmission to sequentially upshift to the maximum allowed gear.
- Pull and hold the left paddle (-) for the lowest allowable gear. This is only available in **Normal** and **Sport** drive modes.

Note: Do not use the temporary neutral position if you plan to tow your vehicle. Use the manual park release procedure found later in this section.

Note: When in **Drag Strip** mode, the transmission automatically upshifts at the maximum engine RPM.

Note: Engine damage may occur if you maintain excessive engine revving without shifting.

To exit SelectShift when in manual (M), deselect manual by pressing the (M) on the gear selector.

Upshift to the recommended shift speeds according to the following chart:

Upshifts when accelerating (recommended for best fuel economy)	
Shift from:	
1 - 2	15 mph (24 km/h)
2 - 3	20 mph (32 km/h)
3 - 4	25 mph (40 km/h)
4 - 5	30 mph (48 km/h)
5 - 6	40 mph (64 km/h)
6 - 7	50 mph (80 km/h)

The instrument cluster displays your currently selected gear. If you request a gear but it is not available due to vehicle conditions, the current gear flashes three times.

Manual Park Release



WARNING: When doing this procedure, you need to take the transmission out of park (P) which means your vehicle can roll freely. To avoid unwanted vehicle movement, always fully apply the parking brake prior to doing this procedure. Use wheels chocks if appropriate.



WARNING: If the parking brake is fully released, but the brake warning lamp remains illuminated, the brakes may not be working properly. Have your vehicle checked as soon as possible.



WARNING: Do not drive your vehicle until you verify that the stoplamps are working.

Note: For some markets this feature is disabled.

Transmission

Use the manual park release to move your transmission from the park (P) position in the event of an electrical malfunction or emergency.

Activating the Manual Park Release Cable

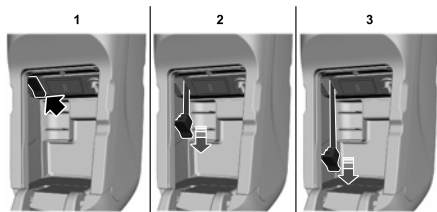

1. Locate the manual park release cable access cover at the bottom of the center storage in the center console.
2. Using a tool, carefully open the access cover.
3. Once in the driver seat, fully apply the brake pedal and hold. Do not release. Pull the loop on the strap until the detent locks in park override mode.
4. Switch the ignition on, but do not start your vehicle. If done correctly, a message on the instrument cluster displays Park Not In Park or Shift System Fault.

Note: Your vehicle is now out of park (P) position and is free to roll.

5. With your foot fully applied on the brake pedal, disengage the parking brake. See **Electric Parking Brake** (page 24).

Note: Switch off the ignition.

This message might not display if the ignition is in the off state.

Returning Your Vehicle to Normal Mode

1. Apply the parking brake. See **Electric Parking Brake** (page 24).

Note: If the vehicle battery is dead, for example, no electrical power available, an external power may be required to apply the parking brake.

2. Fully apply the brake pedal and hold, do not release.
3. Install the access cover.
4. With your foot fully applied on the brake pedal, start your vehicle. Confirm that your vehicle is in the park (P) and that the instrument cluster indicates park (P).
5. If the instrument cluster is not displaying the park (P) position or there is a message stating Park Not Available, apply the parking brake before exiting your vehicle.
6. Confirm the manual park release cable is in the rest position, and the instrument cluster is not displaying the park (P) position or there is a message stating Park Not Available, Transmission Not In Park or Shift System Fault, apply the parking brake before exiting your vehicle. Contact an authorized dealer for service.

Dual Clutch Transmission Adaptive Learning

This feature may increase durability and provide consistent shift feel over the life of your vehicle. A new vehicle or transmission may have firm shifts, soft shifts or both. This operation is considered normal and does not affect function or durability of the transmission. Over time, the adaptive learning process fully updates transmission operation.

Transmission

If Your Vehicle Gets Stuck In Mud or Snow

If your vehicle gets stuck in mud or snow, you may rock it out by shifting between forward and reverse gears, stopping between shifts in a steady pattern. Press lightly on the accelerator in each gear.

Note: Do not rock the vehicle if the engine is not at normal operating temperature or damage to the transmission may occur.

Note: Do not rock the vehicle for more than a minute or damage to the transmission and tires may occur, or the engine may overheat.

TECHNICAL SPECIFICATIONS

Item	Description	
Transmission.	Tremec TR-9070-DCT dual clutch transmission.	
Driveshaft Rear Axle.	3.73	
Gear Ratios.	Gear	Ratio
	1st	3.14
	2nd	2.05
	3rd	1.43
	4th	1.10
	5th	0.86
	6th	0.68
	7th	0.56
	Reverse	2.76

Brakes

GENERAL INFORMATION

Your vehicle has a brake system designed for high speed and superior fade resistance. You may notice occasional brake squeal and elevated levels of brake dust. This is normal and does not affect brake system performance.

Front Brake System

SHW® Multi-piece brake disc with the following features:

- Iron brake ring with directional vent design, including a large effective radius and swept area. Specially designed for storing and dissipating braking energy during track usage.
- Aluminum hat for significant weight savings.
- Floating stainless steel pin design maintains excellent on-road performance while allowing radial expansion during track usage.

Aluminum Knuckle with Heavy-Duty Wheel Bearing

- Aluminum knuckle designed for high stiffness while reducing weight.
- Heavy-duty front wheel bearing designed for track usage.

Six-Piston Monobloc Brembo® caliper with the following features:

- Staggered piston design provides even pad wear on the street and track.
- Fixed bridge and radial mount provides maximum caliper stiffness for excellent pedal feel at minimum weight.

Rear Brake System

SHW® Multi-piece brake disc with the following features:

- Iron brake ring with vented design and large effective radius. Specially designed for storing and dissipating braking energy during track usage.
- Aluminum hat for significant weight savings with iron lining for parking brake function.
- Floating stainless steel pin design maintains excellent on-road performance while allowing radial expansion during track usage.

Four-Piston Monobloc Brembo® caliper with the following features:

- Staggered piston design provides even pad wear on the street and track.
- Reduced drag compared to sliding calipers, especially during track usage.
- Consistent appearance theme with front caliper.

Electric Parking Brake

- Spot caliper on rear brake.

ELECTRIC PARKING BRAKE



WARNING: Apply the parking brake and shift into park (P) before leaving your vehicle.



WARNING: The electric parking brake does not operate if the vehicle battery is running out of charge.

Your vehicle has an electric parking brake. You operate it with a switch instead of a lever. The switch is on the center console.

Note: *The electric parking brake makes noises during operation. This is normal.*

Brakes

Applying the Electric Parking Brake



Pull the switch upward.



The red warning lamp flashes during operation and illuminates when the parking brake is applied.



If it continues to flash or does not illuminate, the system has malfunctioned. Have your vehicle checked as soon as possible.

Note: *It remains illuminated for a short period of time after you switch the ignition off.*

Note: *You can apply the electric parking brake when the ignition is off.*

Note: *The electric parking brake could automatically apply when you shift into park (P). See **Transmission** (page 17).*

Applying the Electric Parking Brake in an Emergency

Note: *Do not apply the electric parking brake when your vehicle is moving, except in an emergency. If you repeatedly use the electric parking brake to slow or stop your vehicle, you could cause damage to the brake system.*

You can use the electric parking brake to slow or stop your vehicle in an emergency.



Pull the switch upward and hold it.



The red warning lamp illuminates, a tone sounds and the brake lamps turn on.



The electric parking brake continues to slow your vehicle down unless you release the switch.

Manually Releasing the Electric Parking Brake

Switch the ignition on.

Press and hold the brake pedal.



Push the switch downward.



The red warning lamp turns off.



If it remains illuminated or flashes, the system has malfunctioned. Have your vehicle checked as soon as possible.

Automatically Releasing the Electric Parking Brake

Close the driver door.

Shift into gear.

Press the accelerator pedal and pull away in a normal manner.



The red warning lamp turns off.



If it remains illuminated or flashes, the electric parking brake has not released. Manually release the parking brake.

Releasing the Electric Parking Brake if the Vehicle Battery is Running Out of Charge

Connect a booster battery to the vehicle battery to release the electric parking brake if the vehicle battery is running out of charge.

Stability Control

USING STABILITY CONTROL

The traction and stability control enhancement system provides different modes of operation for various driving conditions. The system integrates braking, steering and powertrain systems using anti-lock brakes, traction control, electric power-assisted steering and Launch Control to optimize the performance for all driving conditions. See **Drive Control** (page 27).

Driving Aids

DRIVE CONTROL

Selectable Drive Modes

Selectable drive modes deliver a customized driving experience using a variety of electronic vehicle systems. The systems optimize vehicle dynamics and powertrain response based on your selected mode. Systems associated with selectable drive modes are:

- Electronically power assisted steering.
- Electronic stability control and traction control maintain your vehicle control in adverse conditions or high performance driving.
- Electronic throttle control enhances the powertrain response to your driving input.
- Electronic transmission controls enhance the powertrain response to your driving input, optimized for the specific drive mode.
- MagneRide™ dampers.
- Active exhaust adjusts the sound characteristics of your vehicle.



Toggle the mode switch on the center stack under the display screen to change the drive mode.

Drive Modes

Note: Drive mode changes are not available when the ignition is off or when the transmission is in reverse (R).

- **Normal** – Used for normal, every day on road driving. Vehicle response tuned for all-around street driving. Best for fuel economy and smoothness.
- **MyMode** – A custom drive mode the driver can modify. See the section that follows for additional information.
- **Sport** – Used for spirited on road driving. Vehicle response tuned for on road performance.
- **Track** – Used for spirited, aggressive and limit handling while at race tracks or auto crosses. Wheel spin and yaw limits opened up to not interfere with a skilled driver, while retaining some system aids.
- **Drag Strip** – Used at the drag strip. Can use in conjunction with launch control. Optimized for drag strip launches.
- **Slippery** – Used for wet conditions on public roads. System limits yaw and wheel spin to tighter limits than **Normal** mode.

Note: In slippery conditions, starting your vehicle in 2nd gear with slippery drive mode active may improve pull-away traction.

Using MyMode

You can use **MyMode** to create a unique drive mode.

Driving Aids



Selectable Steering and MagneRide™ Dampers



E293836



Press the button to change the steering feel. The first press illuminates the current mode. Subsequent presses changes the mode.



Press the button to adjust the suspension. The first press illuminates the current mode. Subsequent presses changes the mode.

To create or save **MyMode**, press the cobra button on the steering wheel to access the menu. See **General Information** (page 13). The available systems appear on the screen. Select your preferred settings using the appropriate buttons and menus. Press and hold OK to save your settings. The drive mode list adds your **MyMode** and you can select it the next time you start your vehicle.

Note: *There are diagnostic checks that continuously monitor the system to make sure it properly operates. If a mode is unavailable due to a system fault or change in gear position, the selected mode defaults to **Normal**.*

Note: *When you select **Track** mode, Pre-Collision Assist disables.*

Selectable steering modes:

- **Normal** — Standard steering efforts and feedback.
- **Sport** — Slightly higher effort required for steering with more road force felt through the steering wheel.
- **Comfort** — Slightly less effort required for steering with less road force felt through the steering wheel.

Note: *You may feel a soft feedback bump in the steering wheel after you make a selection.*

Note: *Selectable steering defaults to **Normal** if the battery gets disconnected or removed.*

Driving Aids

MagneRide™ Damper modes:

- **Normal** — Available in **Normal**, **Sport** and **Slippery** drive modes.
- **Sport** — Available in **Normal**, **Sport** and **Track** drive modes.
- **Track** — Available only in **Track** drive mode.
- **Drag Strip**— Available only in **Drag Strip** drive mode.

Active Exhaust



Your vehicle has four active exhaust modes. The modes are **Quiet**, **Normal**, **Sport** and **Track**.

Note: *The **Track** exhaust mode setting is only for use at tracks and not for use on public roadways. Use of this setting results in increased exterior noise, which may not meet state and local laws and regulations. It is the obligation of the driver to operate the vehicle in a manner that complies with state and local requirements. Only use the **Track Exhaust Mode** setting at a competition track or an off-road course where elevated exterior vehicle noise is acceptable.*

Towing

TOWING A TRAILER



WARNING: Your vehicle is not approved for trailer towing. Never tow a trailer with your vehicle.

TRANSPORTING THE VEHICLE

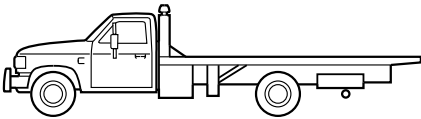

If you need to have your vehicle towed, contact your roadside assistance center or a professional towing service.

We recommend that your vehicle be towed with flatbed equipment only. When towing with a flatbed, race ramps or wood ramps must be used when loading or unloading your vehicle. Wheel baskets are required when flatbed towing.

Your vehicle comes with a front recovery hook to assist in vehicle recovery situations. See **Towing Points** (page 36).

Perform the following when towing your vehicle:

- Enable manual park override. See **Automatic Transmission** (page 17).
- Make sure the electronic parking brake is off. See **Electric Parking Brake** (page 24).

Note: Do not use the Stay in Neutral Mode for towing.

Note: Do not tow with a slingbelt or wheel lift equipment.

Note: If the vehicle is towed incorrectly or by any other means, vehicle damage may occur.

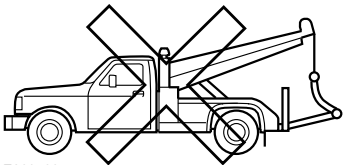
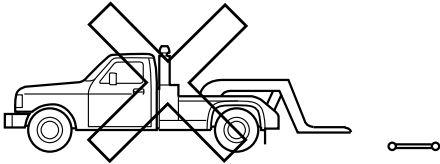

E203788

Towing

Preferred Flatbed Method

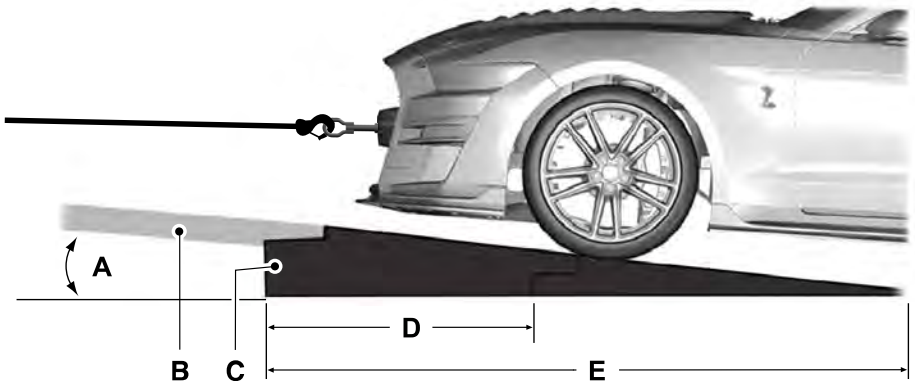

- A Seven degrees maximum.
- B Tow vehicle ramp.
- C Race ramps.
- D 30 inches (76 centimeters) minimum.
- E 70 inches (178 centimeters) minimum.

Use race ramps to load the vehicle.

The diagram illustrates the maximum ramp angle allowable to load your vehicle on a flatbed. Vehicle damage may occur with greater angles.

Ramps must be used to achieve appropriate undercarriage clearances.

Towing

Alternate Flatbed Method

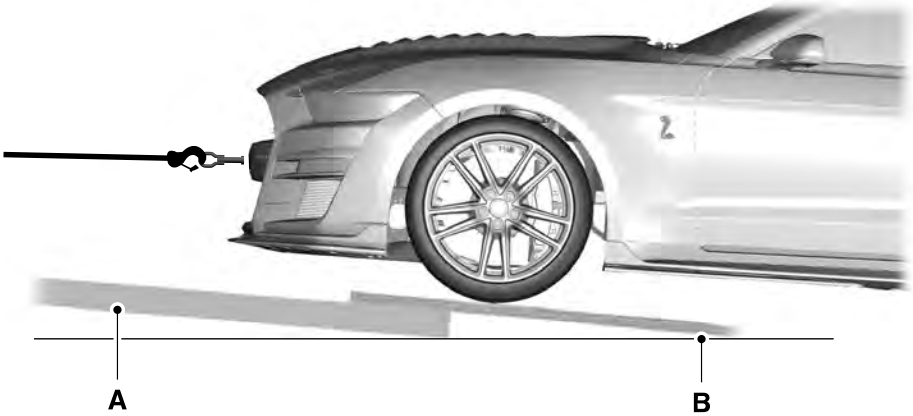

- A Tow vehicle ramp.
- B Wooden ramp.

Use 2 inch x 8 inch x 8 foot wooden ramps to load the vehicle.

The diagram illustrates the maximum ramp angle allowable to load your vehicle on a flatbed. Vehicle damage may occur with greater angles.

Blocks must be used to achieve appropriate undercarriage clearances.

Transporting or Trailering (If Equipped with Carbon Fiber Track Pack)

Due to low ground clearance, your vehicle is transported from the assembly plant to the dealer with front and rear suspension spacers installed. These are removed by the dealer prior to customer delivery and are provided with the vehicle. If you plan to transport or trailer your vehicle and need additional clearance, the spacers may be reinstalled for additional underbody clearance.

Note: *Suspension spacers must be removed before driving your vehicle. Failure to remove the spacers may cause damage to suspension components and degrade vehicle performance.*

Towing

Note: It is only possible for you to install or remove the suspension spacers while the vehicle is raised in the air.

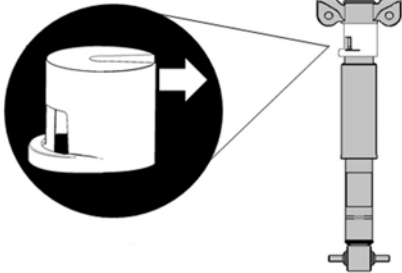
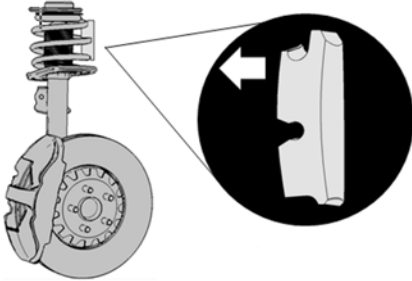

E250502

Front Suspension

Insert the top of the spring spacer onto the spring first, then snap the bottom of the spacer into place.

Rear Suspension

Slide the shock absorber dust boot down by hand, then snap the spacer into place around the shock rod.

TOWING THE VEHICLE ON FOUR WHEELS

Emergency Towing

 **WARNING:** If your vehicle has a steering wheel lock make sure the ignition is in the accessory or on position when being towed.

If your vehicle becomes inoperable without access to a flatbed vehicle transport or trailer, you can tow with all wheels on the ground, known as flat towing, under the following conditions:

- Your vehicle is facing forward for towing in a forward direction.
- The transmission is in neutral (N). If you cannot shift the transmission into neutral (N), you may need to perform the manual park release procedure. See **Automatic Transmission** (page 17). Failing to do so may result in damage to the transmission. Do not use the Stay in Neutral Mode for towing.
- Maximum speed is 20 mph (32 km/h).
- Maximum distance is 4 mi (6 km).

On public roads, only flat tow your vehicle to get out of the way of danger or to provide access for a flatbed trailer to load the vehicle. For example, if your vehicle becomes inoperable on a bridge or road with no shoulder. Flat tow your vehicle the least amount of distance at the lowest speed possible until you reach a safe and suitable area.

Towing

Recreational Towing (Flat Towing)

You cannot recreational tow your vehicle with all wheels on the ground because vehicle or transmission damage may occur. We recommend towing your vehicle with all four wheels off the ground such as when using a car-hauling trailer. Otherwise, you cannot recreational tow your vehicle.

Driving Hints

BREAKING-IN

Your vehicle requires a break-in period. Drive your new vehicle at least 100 mi (160 km) before performing extended wide open throttle maneuvers and at least 1,000 mi (1,600 km) before operating your vehicle at high speeds or track conditions.

Note: *Vary your speed frequently in order to give the moving parts a chance to break in.*

Ground Clearance

Since ground clearance is reduced, use caution when approaching curbs or curb stops from the front and rear as vehicle damage will occur. Additionally, when crossing speed bumps or driveway curbs, Ford Performance recommends approaching at a 45 degree angle to reduce the risk of vehicle damage.

Your vehicle carries the same warranty as other Ford models. Damage caused by accidents, crashes or objects striking the vehicle (including driving through a car wash) or misuse of the vehicle, such as driving over curbs, overloading or racing is not covered under the new vehicle limited warranty. See the Warranty Guide for complete information.

Cold Engine Operation

Your vehicle is designed to restrict engine power and RPM when the engine is cold. The engine RPM and power output is reduced until the engine reaches full operating temperature.

While you can start the vehicle as low as -22°F (-30°C), the transmission does not shift from park (P) until the transmission fluid temperature warms up to above -4°F (-20°C).

DRIVING THROUGH WATER

Your vehicle has aerodynamic devices attached to the underbody designed to help control airflow for superior performance. Therefore, the driver must be especially careful to avoid driving through deep or standing water. If driving through deep or standing water is unavoidable, do not exceed 10 mph (16 km/h). Never drive through water that is higher than the bottom of the wheel rims. Water may enter through the air intake due to the vacuum generated in the engine. Your vehicle warranty does not cover damage caused by the intake of water into the engine.

Roadside Emergencies

TOWING POINTS

Recovery Hook Location

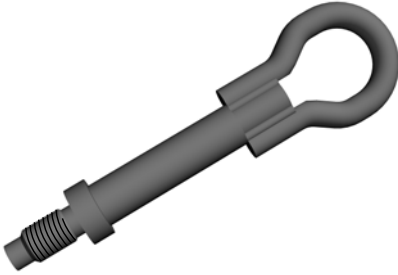

The recovery hook is in the spare wheel storage tray.

Installing the Recovery Hook

There is an installation point for the recovery hook behind the towing eye attachment point cover.

To remove the towing eye attachment point cover:

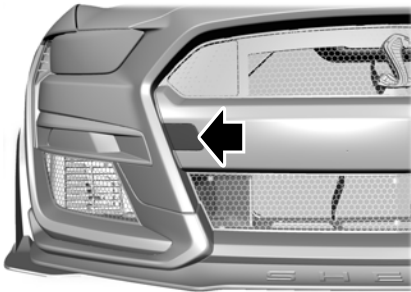

1. Gently press at the position indicated until the left side of the cover pops out.
2. Gently remove the cover from the front fascia by pulling on the left side of the cover, away from the vehicle.

Note: The towing eye attachment point cover has a small lanyard to keep it attached to the bumper. Disconnect the lanyard if necessary.

To install the recovery hook:

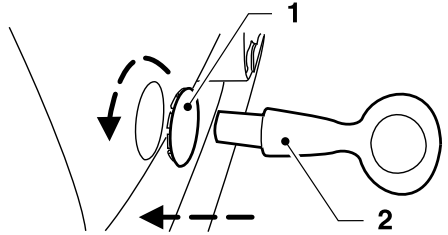

E146284

Insert the recovery hook and turn it counterclockwise to install it. Make sure that you fully tighten the recovery hook.

Note: The recovery hook has a left-hand thread.

To re-install the towing eye attachment point cover:

1. Insert the right side of the cover into the front fascia. There is a protruding edge on the cover that inserts into the fascia.
2. Push the left side of the cover into the front fascia until it is aligned with the fascia and you hear a snap.

Fuses

FUSE SPECIFICATION CHART

See the Owner's Manual for your vehicle's fuse information.

Maintenance

OPENING AND CLOSING THE HOOD

Opening the Hood



E142457

1. Inside the vehicle, pull the hood release handle located under the left-hand side of the instrument panel.

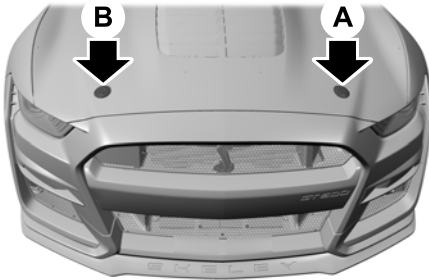

2. Press the driver side hood pin (A) first, then the passenger side hood pin (B).

Note: If you find your hood pin button efforts to be high, apply light downward pressure to the outer bezel of the hood pin, then press the hood pin button.

3. Slightly lift the hood.

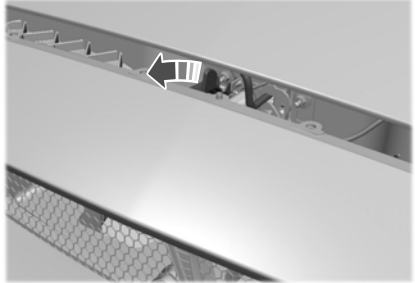

4. Release the hood latch by pushing the secondary release lever to your left-hand side and open the hood.

Closing the Hood

Lower the hood and allow it to drop under its own weight for the last 8–12 in (20–30 cm).

Note: Make sure that the hood is fully closed before driving your vehicle. A warning indicator appears in the instrument cluster if the hood is not fully closed.

Maintenance

UNDER HOOD OVERVIEW

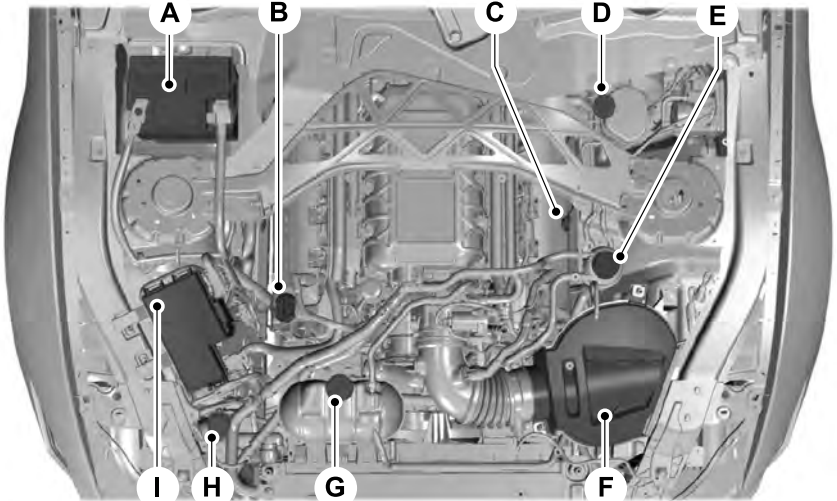

- A Battery.
- B Engine oil filler cap.
- C Engine oil dipstick.
- D Brake fluid reservoir.
- E Intercooler coolant reservoir.
- F Air filter assembly.
- G Engine coolant reservoir.
- H Windshield washer reservoir.
- I Power distribution box.

ENGINE OIL CHECK

See the scheduled maintenance information (including the "Protecting Your Investment" section) for the appropriate intervals for checking the engine oil.

Note: For operating your vehicle on a track, follow the recommended instructions for engine oil changes. See **Track Use** (page 44).

1. Make sure the vehicle is on level ground.

Maintenance

2. Turn the engine off and wait 15 minutes for the oil to drain into the oil pan.
3. Set the parking brake and make sure that the transmission is in park (P).
4. Open the hood. Protect yourself from engine heat.
5. Locate and carefully remove the engine oil level dipstick.
6. Wipe the dipstick clean. Insert the dipstick fully, then remove it again.
7. Put the dipstick back in and make sure it is fully seated.
 - If the oil level is between the lower and upper holes, the oil level is acceptable. DO NOT ADD OIL.
 - If the oil level is below the lower hole, add enough oil to raise the level within the lower and upper holes.

Engine Oil Recommendation

Use Motorcraft SAE 5W-50 full synthetic or an equivalent SAE 5W-50 full synthetic oil meeting Ford specification WSS-M2C931-C.

Do not use supplemental engine oil additives, cleaners or other engine treatments. They are unnecessary and could lead to engine damage that is not covered by Ford warranty.

Change your engine oil and filter according to the appropriate schedule listed. See **Scheduled Maintenance** (page 71).

CHANGING THE ENGINE OIL AND OIL FILTER

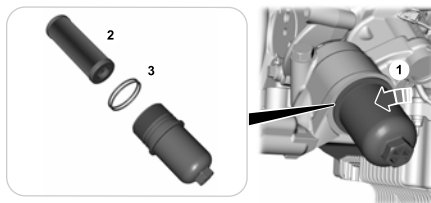

1. Loosen the oil filter housing and allow the oil to drain.
2. Remove the oil filter housing and discard the oil filter element.
3. Remove and discard the O-ring seals.
4. Wipe the O-ring seal surfaces and threads with a clean rag.

Inspect the oil filter housing and stem for damage including cracks or separation of the stem from the housing. If damaged, you must install a new oil filter housing assembly. Also, make sure you remove all components of the oil filter from the housing and oil filter adapter.

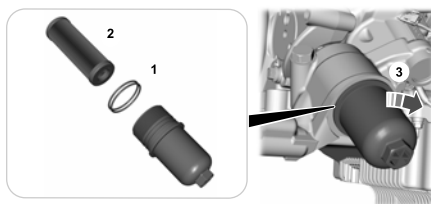

1. Install new O-ring seals on the oil filter housing and lubricate with clean engine oil.

Note: Failure to install new oil filter housing-to-engine oil filter adapter seals may result in oil leakage.

Note: The smallest o-ring that comes with the filter is not used in this application.

Maintenance

2. Install a new oil filter element.
3. Install the oil filter housing. Torque to 16–19 lb.ft (22–26 Nm) using a torque wrench.

Note: Use only a Motorcraft FL-2087 oil filter for maximum performance, reliability and durability.

Note: The use of any oil filter other than the dealer supplied oil filter may cause engine damage.

See the Engine Oil Check section in the Maintenance chapter of your Owner's Manual for information on checking the engine oil.

ENGINE COOLANT CHECK

The concentration and level of engine coolant should be checked at the mileage intervals listed in the scheduled maintenance information.

Note: Make sure that the level is between the **MIN** and **MAX** marks on the engine and coolant reservoirs.

Note: Coolant expands when it is hot. The level may extend beyond the **MAX** mark. If the level is at the **MIN** mark, add coolant immediately.

The coolant concentration should be maintained within 48% to 50%, which equates to a freeze point between -30°F (-34°C) and -34°F (-37°C).

Note: For best results, coolant concentration should be tested with a refractometer such as Rotunda tool 300-ROB75240 available from your dealer. We do not recommend the use of hydrometers or coolant test strips for measuring coolant concentrations.

Be sure to read and understand Precautions in your Owner's Manual. If the coolant has not been checked at the recommended interval, the engine coolant reservoir may become low or empty. If the reservoir is low or empty, add coolant to the reservoir. See Adding Engine Coolant in this chapter.

Note: Automotive fluids are not interchangeable. Do not use engine coolant, antifreeze or windshield washer fluid outside of its specified function and vehicle location. For more information about engine coolant, see the Maintenance chapter of the Owner's Manual.

Adding Engine Coolant



WARNING: Do not add engine coolant when the engine is on or the cooling system is hot. Failure to follow this instruction could result in personal injury.



WARNING: Do not put coolant in the windshield washer reservoir. If sprayed on the windshield, coolant could make it difficult to see through the windshield.



WARNING: To reduce the risk of personal injury, make sure the engine is cool before unscrewing the coolant pressure relief cap. The cooling system is under pressure. Steam and hot liquid can come out forcefully when you loosen the cap slightly.



WARNING: Do not add coolant further than the **MAX** mark.

Maintenance

Note: Do not use stop leak pellets, cooling system sealants, or additives as they can cause damage to the engine cooling or heating systems. This damage would not be covered under your vehicle's warranty.

Note: During normal vehicle operation, the engine coolant may change color from orange to pink or light red. As long as the engine coolant is clear and uncontaminated, this color change does not indicate the engine coolant has degraded nor does it require the engine coolant to be drained, the system to be flushed, or the engine coolant to be replaced.

- DO NOT MIX different colors or types of coolant in your vehicle. Make sure the correct coolant is used. Mixing of engine coolants may harm your engine's cooling system. The use of an improper coolant may harm engine and cooling system components and may void the warranty.
- In case of emergency, a large amount of water without engine coolant may be added in order to reach a vehicle service location. In this instance, the cooling system must be drained, chemically cleaned with Motorcraft® Premium Cooling System Flush, and refilled with prediluted coolant as soon as possible. Water alone without engine coolant can cause engine damage from corrosion, overheating or freezing.

Note: Do not use alcohol, methanol or brine or any engine coolants mixed with alcohol or methanol antifreeze coolant. Alcohol and other liquids can cause engine damage from overheating or freezing.

Note: Do not add extra inhibitors or additives to the coolant. These can be harmful and compromise the corrosion protection of the engine coolant.

Unscrew the cap slowly. Any pressure could escape as you unscrew the cap.

Add prediluted engine coolant meeting our specification. See the Capacities and Specifications chapter of the Owner's Manual for more information. Whenever coolant has been added, the coolant level in the coolant reservoir should be checked the next few times you drive the vehicle. If necessary, add enough prediluted coolant to bring the coolant level to the proper level.

Coolant Refill Procedure

The following procedure should be used when refilling the cooling system after it has been drained or become extremely low.

1. Remove the pressure relief cap from the coolant reservoir as previously outlined.
2. Slowly add prediluted coolant to the coolant reservoir until the coolant level is between the **MIN** and **MAX** marks on the reservoir.
3. Reinstall the pressure relief cap.
4. Start and idle the engine until the upper radiator hose is warm, which indicates the thermostat is open and coolant is flowing through the entire system.
5. Shut the engine off and let it cool.
6. Remove the pressure relief cap from the coolant reservoir as previously outlined.
7. Add prediluted coolant to the coolant reservoir until the coolant level is between the MIN and MAX marks on the reservoir.
8. Reinstall the pressure relief cap.
9. Check the coolant level in the reservoir before you drive your vehicle the next few times with the engine cool.
10. If necessary, add prediluted coolant to the coolant reservoir until the coolant level is between the **MIN** and **MAX** marks on the reservoir.

Maintenance

Whenever coolant has been added, the coolant level in the coolant reservoir should be checked the next few times you drive the vehicle. If necessary, add prediluted coolant to bring the coolant level to the proper level.

If you have to add more than 1 qt (1 L) of coolant per month, have your dealer check the cooling system. Your cooling system may have a leak. Operating an engine with a low level of coolant can result in engine overheating and possible engine damage.

CHANGING THE ENGINE AIR FILTER



WARNING: To reduce the risk of vehicle damage and personal burn injuries, do not start your engine with the air cleaner removed and do not remove it while the engine is running.

See the scheduled maintenance information for the appropriate intervals for changing the air filter element. See **Normal Scheduled Maintenance** (page 74).

When changing the air filter element, only use the Motorcraft™ air filter element listed. See **Motorcraft Parts** (page 64).

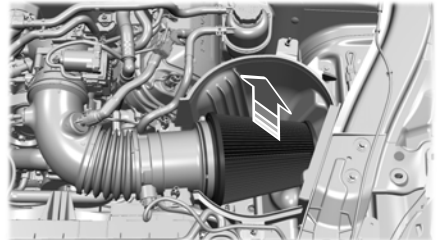
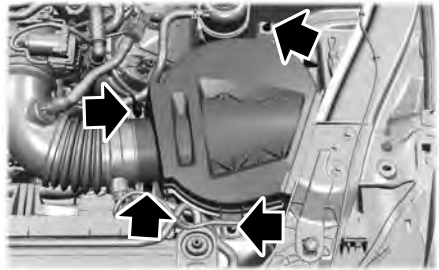

1. Open the hood. See **Opening and Closing the Hood** (page 38).
2. Remove the wiring retainers by pulling them straight up and off of the studs.
3. Remove the fasteners securing the air box lid to the air box.
4. Loosen the air filter clamp bolt enough to slip the air filter off of the air filter housing.
5. Wipe the air filter housing clean to remove any dirt or debris.
6. Install the new air filter taking care not to damage the air filter element and tighten the hose clamp.
7. Install the fasteners that secure the air box lid to the air box.
8. Install the wiring retainers by pushing them onto the fastener studs.
9. Close the hood.

Track Use



WARNING: *Track Apps™* is for track use only. Remember that even advanced technology cannot defy the laws of physics. It is always possible to lose control of a vehicle due to inappropriate driver input for the conditions. Aggressive driving on any road condition can cause you to lose control of your vehicle increasing the risk of personal injury or property damage.

Participating in track events or other competitive driving without following the instructions provided may affect the vehicle warranty. See the warranty manual before using the vehicle for racing or other competitive driving.

Operating at High Speeds and on Track Days

Your vehicle is capable of sustained high speeds and track day driving.

Note: *Obey all traffic laws and only operate your vehicle at locations designed to do so safely.*

Before operating your vehicle at high speeds, follow these guidelines:

- Inspect wheels and tires for wear and damage. Replace any damaged wheels or tires.
- Verify your tires have the correct tire pressure. See **Tires** (page 58).
- Do not operate your vehicle at high speeds with more than one additional passenger or while carrying cargo.
- Verify that the engine oil, engine coolant and brake fluid are at appropriate levels.

- Your vehicle has electronic controls to reduce power and/or limit RPM to reduce powertrain temperatures if required.
- Perform the brake burnish procedure found later in this section.

Prior to track or other events at high speed:

- Change the engine oil with fresh Motorcraft/Ford SAE 5W-50 Full Synthetic Motor Oil and replace the engine oil filter prior to the event. Change the engine oil and filter again after every four hours of track time.
- Replace the brake fluid with fresh Motorcraft/Ford DOT 4 LV High Performance Brake Fluid or other DOT compliant fluid with a dry boiling point greater than 500°F (260°C) from a sealed container. Do not use silicone or DOT 5 brake fluids.

Regularly check the engine oil level during the event. If the oil level is between the lower and upper holes, the oil level is acceptable. DO NOT ADD OIL. If the oil level is below the lower hole, a message appears in the information display. Add enough oil to raise the level within the lower and upper holes. See **Engine Oil Check** (page 39).



Replace the rear axle fluid after 500 mi (800 km) of track use or when a warning indicator and red warning message appears in the information display stating that the axle is over temperature. See **Special Operating Conditions Scheduled Maintenance** (page 77).

Track Apps™

This feature provides a suite of menu options to record and optimize your track performances. See **General Information** (page 13).

Track Use

Note: *Track Apps™ are for track use only. Do not use them under any other driving conditions.*

Note: *You cannot view or clear your results unless your vehicle is at a complete stop with the right arrow on the display menu inactive. If your vehicle does not reach 100 mph (160 km/h) during the track run, your display may not show your selected interval's results.*

Note: *The pre-collision assist system turns off when using Track Apps™ or when you switch off your stability control system.*

Acceleration Timer

Displays your vehicle's rate of acceleration for a given speed or distance range.

Accelerometer

Displays your vehicle's rate of acceleration or deceleration. A dot moves toward the area of acceleration or deceleration.

LEFT Acceleration or Deceleration

When accelerating or decelerating left, the dot moves to the right on the accelerometer.

RIGHT Acceleration or Deceleration

When accelerating or decelerating right, the dot moves to the left on the accelerometer.

Brake Performance

Displays your vehicle's rate of deceleration for a given speed range.

Exhaust Mode

Gives the driver the ability to choose the vehicle's exhaust mode. A button is on the center stack for quick adjustment of this setting. See **Drive Control** (page 27).

Note: *The Track exhaust mode setting is only for use at tracks and not for use on public roadways. Use of this setting results in increased exterior noise, which may not meet state and local laws and regulations. It is the obligation of the driver to operate the vehicle in a manner that complies with state and local requirements. Only use the Track Exhaust Mode setting at a competition track or an off-road course where elevated exterior vehicle noise is acceptable.*

Lap Timer

Gives you the ability to record lap times at three separate tracks.

Launch Control

Note: *The engine and transmission need to be sufficiently warmed up before you can enable launch control.*

Maximizes your vehicle's traction from a standing start.

To use launch control, follow these steps:

1. Bring your vehicle to a complete stop.
2. Make sure launch control is enabled. The indicator illuminates in the instrument display when launch control is enabled.
3. Shift the transmission into drive (D) and apply the brakes.
4. Fully depress the accelerator pedal and allow the engine RPM to stabilize.
5. Release the brake.

Note: *For an explanation of the transmission warning messages, See **Automatic Transmission** (page 17).*

Track Use

Line Lock

Line lock is a feature intended for use at tracks only and should not be used on public roadways. Use of this feature may result in significantly increased rear tire wear. It is intended to condition the rear tires to maximize traction prior to track use. Line lock maintains brake force at the front wheels, allowing the rear wheels to spin with minimal vehicle movement.

This feature is located in the **Track Apps™** menu. Make selections through the 5-way information display control and **OK** button on the steering wheel.

Using Line Lock

There are three line lock stages:

- Initiated.
- Engaged.
- Off.

Initiating Line Lock

The initiation stage verifies that the vehicle is ready for line lock function, and confirms driver intent. Follow the prompts in the information display to initiate line lock.

The following conditions must be met to initialize line lock:

- The vehicle is on a level surface.
- The engine is running.
- The vehicle is traveling less than 25 mph (40 km/h).
- Selectable drive mode is not in slippery mode.
- There are no electronic stability control faults.



To cancel line lock once it is initialized, press the Cobra button.

Once initiated, line lock is prepared for activation and remains initiated up to 25 mph (40 km/h). If vehicle speed exceeds 25 mph (40 km/h), line lock automatically cancels.

Note: *At a drag strip with a water box, it is recommended that traction control is disengaged prior to entering the water box. This allows for a pull away out of the water box after the tires are heated. Traction control must be re-engaged to have launch control capability at the start line.*

Note: *Leaving traction control off for launch maintains set RPM but does not manage tire spin.*

Engaging Line Lock

Follow the prompts in the information display to engage line lock after it is initialized. To engage, firmly apply the brakes. Then press the OK button. Once engaged, release the brake pedal. The front brakes remain applied and the rear brakes release. At this point, the engagement timer is initiated and shown on the driver information display.

The following conditions must be met to engage line lock:

- The vehicle is on a level surface.
- The engine is running.
- The vehicle is stopped.
- The parking brake is not applied.
- The driver door is closed.
- The transmission is in a forward gear.
- Selectable drive mode is not in slippery mode.
- There are no electronic stability control faults.
- The steering wheel must be in the straight ahead position.

Track Use

Releasing Line Lock

While line lock is engaged, you can exit (release) the feature using the OK button. When you press the OK button, line lock releases immediately and normal vehicle function resumes. When line lock engages, a countdown timer shows the remaining time before line lock is released automatically. If you exceed the time limit, or another vehicle condition requires line lock to release, the system safely disengages and normal vehicle function resumes.

Note: *If you apply the brake pedal while line lock is engaged, line lock automatically cancels and normal brake function resumes.*

Performance Shift Indicator

The performance shift indicator displays a row of colored lights that represent engine RPM.

The performance shift indicator menu allows you to:

- Choose whether the indicator is shown on the windshield or information display.
- Set a shift point within the allowable RPM range in increments of 100.
- Enable or disable the associated shift tone, based on the set shift point.
- Set the mode between Off, Change with Drive Mode, Tach, Track and Drag.
- Set the light intensity. The intensity automatically adjusts between day time and night time.

GT500

Front	Track	Street
Camber	-2.00°	-0.92°
Caster	7.81°	7.81°
Toe - Total	-0.10° (toe out)	-0.10° (toe out)

Status Screen

The status screen provides a snapshot of the current status of the Drive Mode, AdvanceTrac, Exhaust Mode, Steering Effort, Launch Control and Damper features.

View/Clear Results

Allows you to view and clear the last and saved results of the **Acceleration Timer**, **Brake Performance**, and **All Time Best** results.

Road Course Alignment Recommendations

Note: *After your track day is complete, return your car to the street alignment and tire pressures.*

Note: *Using these wheel alignment settings may cause excessive tire wear. Only use these settings for racing or competitive driving. Excessive tire wear is not covered under the vehicle warranty.*

If you plan to participate in road course track days with your GT500 or GT500 Track, we recommend the following chassis settings for optimal tire wear and handling performance.

All settings are at curb loading condition.

Requires adjustable camber front strut top mounts.

Track Use

Rear	Track	Street
Camber	-2.20 ¹	-1.70 ²
Toe - Total	0.30° toe in	0.30° toe in

¹For road course use, adjust the rear camber to no more negative than -2.2°.

²For drag strip use, adjust the rear camber to no more positive than -1.0°. Do not exceed nominal street front camber.

GT500 Carbon Fiber Track Pack

Front	Track	Street
Camber	-2.25°	-1.06°
Caster	8.08°	8.08°
Toe - Total	-0.10° (toe out)	-0.10° (toe out)

Rear	Track	Street
Camber	-2.20 ¹	-1.70 ²
Toe - Total	0.30° toe in	0.30° toe in

¹For road course use, adjust the rear camber to no more negative than -2.2°.

²For drag strip use, adjust the rear camber to no more positive than -1.0°. Do not exceed nominal street front camber.

Track Tire Pressures

Cold Tire Pressures

Tire pressure	Front	Rear
GT500	28 psi (1.93 bar)	28 psi (1.93 bar)
GT500 Carbon Fiber Track Pack		

Track Use

Hot Tire Pressures

Tire pressure	Front	Rear
GT500	38 psi (2.62 bar)	36 psi (2.48 bar)
GT500 Carbon Fiber Track Pack		

Adjustable Camber Front Strut Top Mounts (If Equipped)

Your vehicle has adjustable strut mounts which you can use to adjust the camber of your vehicle before and after a track event to the specifications listed in the Road Course Alignment Recommendations table previously shown.

Note: After your track day is complete, return your car to the street alignment and tire pressures.

Track Aerodynamic Components

(If Equipped)

Note: The front splitter wickers and rear Gurney flap are for track use only and must not be used on public roads.

Note: The rain tray must remain installed for on-road driving.

Some aerodynamic components are delivered but not installed on your vehicle. These are intended to be installed for track use only. The components include:

- Front splitter wickers.
- Rear Gurney flap.

See the chart that follows for recommended aerodynamic component usage.

Model	Vehicle Usage	Front Splitter Wickers	Rain Tray	Rear Gurney Flap	Rear Wing Angle
GT500	Street	Do not use	Do not remove	Do not use	N/A
	Track/Off-Road	Install	Remove	Install	N/A
GT500 Carbon Fiber Track Pack	Street	Do not use	Do not remove	N/A	Low position
	Track/Off-Road	Install	Remove	N/A	High position

Track Use

Rain Tray

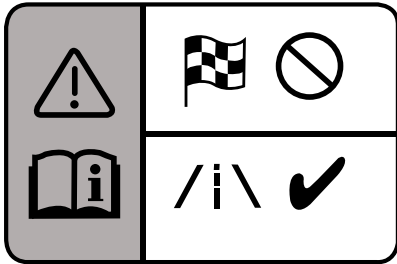

The rain tray must be installed for on-road driving.

Your vehicle comes with a removable rain tray installed under the hood scoop.

Remove the rain tray for the following reasons:

- For road course use.
- For cleaning.

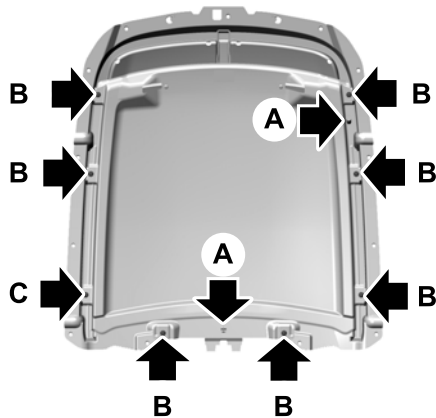

To remove the rain tray:

1. Open the hood. See **Opening and Closing the Hood** (page 38).
2. Partially remove the slotted T25 torx fastener (C).
3. Remove the seven T25 torx fasteners (B).
4. Slide the rain tray off of the slotted T25 torx fastener (C) and remove the rain tray. The slotted fastener helps secure the rain tray while you remove the other fasteners.
5. Fully remove the slotted T25 torx fastener (C).

Note: Use special care when removing the fasteners so they do not fall into the engine compartment.

To install the rain tray:

1. Align the rain tray with the alignment posts (A) on the hood.
2. Partially install the slotted T25 torx fastener (C) so that you can slide the rain tray onto it. The slotted fastener helps secure the rain tray while you install the other fasteners.
3. Install the seven T25 torx fasteners (B).
4. Fully install the slotted T25 torx fastener (C).
5. Close the hood. See **Opening and Closing the Hood** (page 38).

Adjustable Rear Wing

The rear wing generates aerodynamic down-force at speeds greater than 50 mph (80 km/h).

Regularly inspect the rear wing panel and attachment points for damage or looseness.

You can adjust the wing using the hole pattern at the top of the stanchion.

Track Use

Moving the wing up increases rear down force and overall understeer. Moving the wing down decreases the rear down force and overall understeer.

Rear Gurney Flap

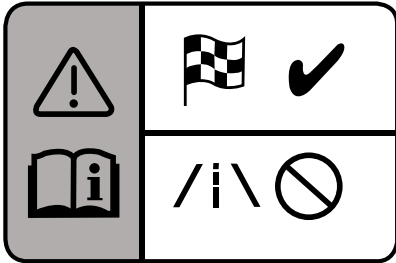

The rear Gurney flap must be removed for on-road driving.

Your vehicle may include a removable Gurney flap in the luggage compartment. The Gurney flap greatly enhances high speed stability and performance on the track. It is recommended that you use the Gurney flap at all tracks featuring high speed corners and can be used at any track regardless of cornering speeds.

Smaller tracks with maximum cornering speeds below 70 mph (112 km/h) may benefit from the removal of the Gurney flap to improve low speed balance. It is recommended that the user attaches the Gurney flap for all track events and carefully assess both the vehicle's condition and the users capability before removal.

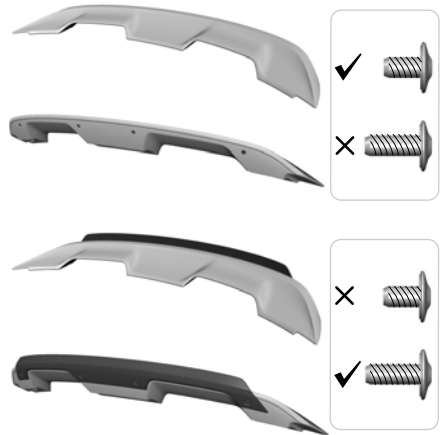

Note: The Gurney flap comes with longer size bolts to install it onto the rear spoiler. **Do not use the longer size bolts without the Gurney flap attached or damage to the spoiler may occur.**

Front Splitter Wickers

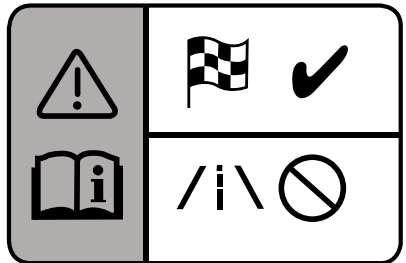

The front splitter wickers must be removed for on-road driving.

Track Use

Your vehicle may include a front splitter and front splitter wickers in the luggage compartment. It is recommended that you use the front splitter wickers at all tracks featuring high speed corners and can be used at any track regardless of cornering speeds.

Installing and Removing the Front Splitter Wickers

1. Raise the front of the vehicle to access the fastening locations.

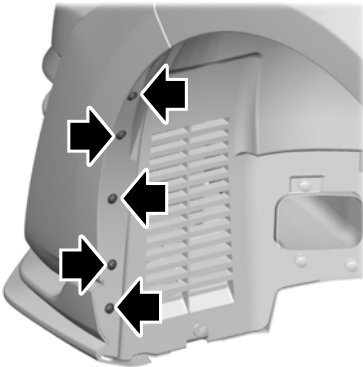

2. Remove the five bolts from the wheel liner.

Note: Retain 2 bolts and store them in a safe location. These are required when the front splitter wickers are not installed.

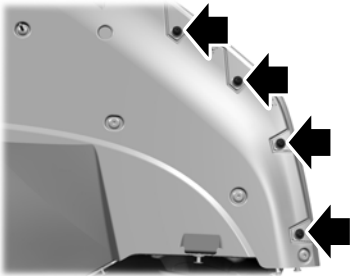

3. Remove the four M6 screws from the outboard corner of the splitter.

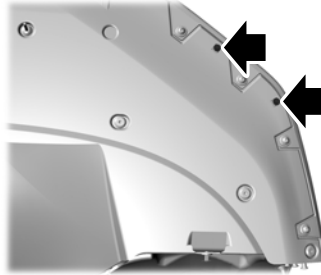

4. Install the two M4.2 push nuts into the bottom of the front splitter.

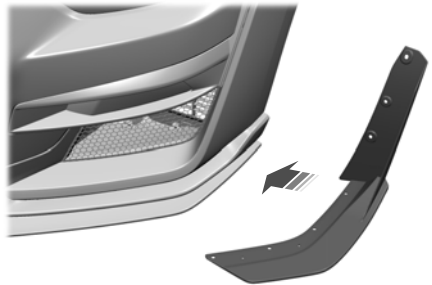

5. Locate the splitter wicker to the vehicle. The face of the splitter wicker with the three attaching holes should be aligned to the wheel liner bracket.

Track Use

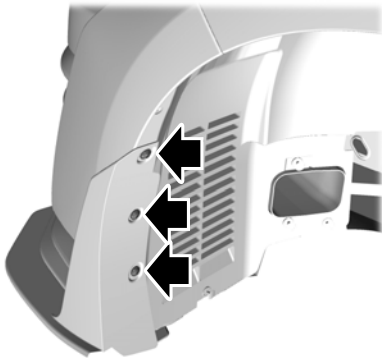

6. Loosely install 3 of the bolts removed in step 2 to the wheel liner bracket.

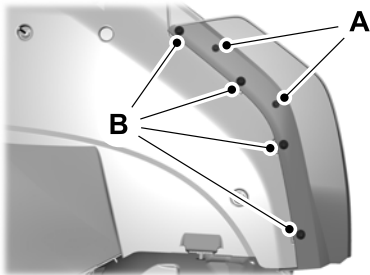

7. Loosely install two M4.2 screws (A) to the bottom of the splitter.
8. Install four M6 bolts (B) to the bottom of the splitter. Torque to 71 lb.in (8 Nm) starting at the rearmost fastener and working forward.
9. Torque the two M4.2 screws (A) on the bottom to 17 lb.in (1.9 Nm). Torque the three M6 bolts to the wheel liner bracket from step 6 to 48 lb.in (5.4 Nm).

Remove the front splitter wickers in the reverse order of installation.

Catch Can

If you plan to track your vehicle and it did not come with an oil catch can as part of the Carbon Fiber Track Pack, we recommend that you purchase the catch can kit through your authorized dealer or Ford Performance Parts Catalog.

Installation instructions are included with the catch can.

The catch can has a self-draining feature and does not require any maintenance.

Brake Burnishing

Your brakes should be properly burnished prior to heavy track use. Excessive brake noise may occur after the track burnish or track use. Perform this procedure in a safe manner on dry pavement, and in compliance with all local and state ordinances and laws regarding motor vehicle operation.

To burnish your brakes for track use:

- Initial low temperature bedding:
 - If your brakes already have 200 miles or more of city driving, skip this step and go directly to the high temperature bedding cycle procedure. Otherwise, perform at least 30 stops from approximately 50 mph (80 km/h) at 1/3 g deceleration with 0.75 mi (1.2 km) spacing between stops. A deceleration gauge can be accessed through the TrackApps menu in your instrument display.
- High temperature bedding cycle:
 - Beginning with cool brakes, perform 15 consecutive stops back to back, accelerating at 3/4 throttle to 80 mph (128 km/h) and braking to 20 mph (32 km/h) at 1.0 g deceleration. The brakes may omit an odor or smoke during this part of the procedure.

Track Use

- Cool down:
 - Cool the brakes down by driving 1-2 laps [5 mi / 8 km] at 60 mph (96 km/h) with minimal to no brake usage.
- Recovery low temperature bedding (if time allows):
 - Perform at least 30 stops from approximately 50 mph (80 km/h) at 1/3 g deceleration with 0.75 mi (1.2 km) spacing between stops. A deceleration gauge can be accessed through the TrackApps menu in your instrument display.

Vehicle Care

GENERAL INFORMATION

Lifting Your Vehicle

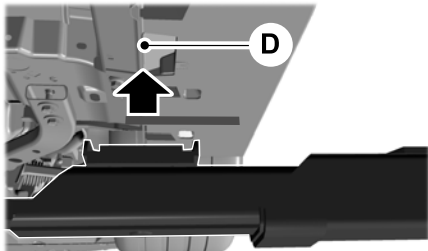
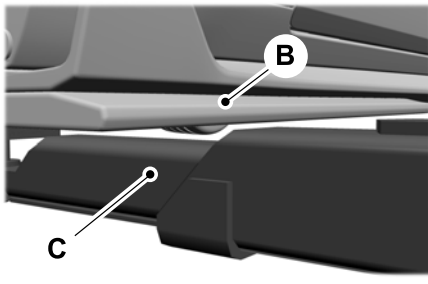
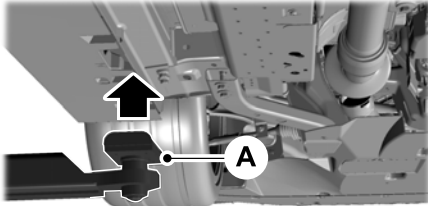

- A Hoist pad.
- B Rocker molding.
- C Hoist arm.
- D Sill flange.

Using a Two Post Vehicle Hoist

When using a vehicle hoist, make sure the rocker moldings (B) do not contact or interfere with the hoist arms (C) or damage to your vehicle may occur.

Follow these steps to hoist your vehicle:

1. Align your vehicle with the hoist and position the hoist pads (A) to align with the sill flange (D).
2. Lift the hoist until all four hoist pads (A) make contact with the sill flange (D).

Note: The hoist pad (A) may contact the bottom of the rocker molding (B). If the vehicle is hoisted from the proper location this does not damage the part.

3. Inspect all hoist arms (C) for any interference or contact with the rocker molding (B).
4. If there is no contact with any hoist arm (C), your vehicle can be lifted safely.

If there is contact with any hoist arm (C), do not lift the vehicle and follow these instructions:

1. Make sure the hoist arms (C) are fully lowered to the ground.
2. If necessary, adjust the hoist pad (A) height until it makes contact with the sill flange (D) and the rocker molding (B) is clear from the hoist arm. Hoist pad (A), height can usually be adjusted by rotating the hoist pad (A) counter-clockwise.
3. If the vehicle hoist does not use adjustable pads, install spacers onto the hoist pad (A) for the same effect.

Note: Do not use wood spacers as they could split along the grain of the wood.

Vehicle Care

4. Raise the hoist until the hoist pads (A) make contact with the sill flange (D). Make sure there is no contact between the rocker molding (B) and all hoist arms (C) before lifting the vehicle.

To maintain proper cooling and aerodynamics at high speeds, your vehicle has heat exchangers integrated with the front fascia designed to maximize performance. Do not use a power washer or high powered spray nozzle as damage to the cooling fins could occur.

CLEANING THE EXTERIOR

Washing Your Vehicle (Base Vehicle)

Note: Do not use a touchless car wash or any kind of commercial car wash equipment with front splitter wickers installed.

Note: Always hand wash your vehicle if you have vinyl stripes.

Do not drive your vehicle through an automated, commercial car wash due to the vehicle's low ground clearance and tire width. Wash your vehicle by hand, or by using a touchless commercial wash with no mechanical tracks on the floor. Do not use a power washer or high pressure wand.

To maintain proper cooling and aerodynamics at high speeds, your vehicle has heat exchangers integrated with the front fascia designed to maximize performance. Do not use a power washer or high powered spray nozzle as damage to the cooling fins could occur.

Note: For heavy accumulation of debris or dirt, clean with a non-metallic soft bristle car wash brush and warm soapy water as needed.

Washing Your Vehicle (Carbon Fiber Track Pack)

Always wash your vehicle by hand. Do not use a power washer or high pressure wand.

Note: For heavy accumulation of debris or dirt, clean with a non-metallic soft bristle car wash brush and warm soapy water as needed.

Wheels and Tires

WHEELS

Your vehicle has unique wheels matched to the tires. These wheels are more susceptible to damage due to their diameter, width and low profile tires.

To avoid damage to your wheels:

- Maintain proper tire pressure (see Tires in this supplement).
- When installing wheels, always torque lug nuts to specification with a torque wrench.
- Inspect your wheels for damage on a regular basis. If a wheel is damaged, replace it immediately.
- In the event that you encounter an abnormally harsh impact, inspect the outer diameter of your wheels, both inside and out, for damage.

Use Motorcraft™ Wheel and Tire Cleaner to maintain your wheels. See your Owner's Manual for information on other cleaning products and vehicle care.

Wheel Lug Nut Torque Specifications



WARNING: When you install a wheel, always remove any corrosion, dirt or foreign materials present on the mounting surfaces of the wheel or the surface of the wheel hub, brake drum or brake disc that contacts the wheel. Make sure to secure any fasteners that attach the rotor to the hub so they do not interfere with the mounting surfaces of the wheel. Installing wheels without correct metal-to-metal contact at the wheel mounting surfaces can cause the wheel nuts to loosen and the wheel to come off while your vehicle is in motion, resulting in loss of vehicle control, personal injury or death.

Retighten the lug nuts to the specified torque at 500 mi (800 km) after any wheel disturbance (tire rotation, changing a flat tire or wheel removal).

Lug nut size	lb-ft (Nm)*
M14 x 1.5	150 ± 15 (200 ± 20)

*Torque specifications are for nut and bolt threads free of dirt and rust. Use only Ford recommended replacement fasteners.

Carbon Fiber Wheels (if Equipped)

Carbon fiber wheels offer significant weight savings, while maintaining the structural integrity of aluminum or steel wheels. These wheels have been specifically designed for your vehicle, and are not recommended for use on other vehicles or Mustang variants. Due care should be taken when mounting and balancing new tires to avoid damage. Ford Performance recommends only using your Ford authorized dealer for service.

The front carbon fiber wheels have a thermal barrier coating on the back of the spokes and on the inner rim barrel. The coating works best when clean. Maintain these areas with Motorcraft Tire and Wheel Cleaner and warm soapy water.

Wheels and Tires

TIRES



WARNING: Only use replacement tires and wheels that are the same size, load index, speed rating and type (such as P-metric versus LT-metric or all-season versus all-terrain) as those originally provided by Ford. The recommended tire and wheel size may be found on either the Safety Compliance Certification Label (affixed to either the door hinge pillar, door-latch post, or the door edge that meets the door-latch post, next to the driver's seating position), or the Tire Label which is located on the B-Pillar or edge of the driver's door. If this information is not found on these labels, then you should contact your authorized dealer as soon

as possible. Use of any tire or wheel not recommended by Ford can affect the safety and performance of your vehicle, which could result in an increased risk of loss of vehicle control, vehicle rollover, personal injury and death.

Note: *Do not use tire chains on your vehicle. The use of any type of tire chain on these tires could damage your vehicle.*

Your vehicle is equipped with low profile, high performance tires that are designed to optimize the driving dynamics you expect in a Ford Performance vehicle. These tires are not optimized for off-road or winter (snow or cold weather) performance, and their ride, noise and wear characteristics are different than non-performance tires. Also, because of their lower profile, the tires are more susceptible to damage due to potholes and rough roads.

	Tires	Wheels (inches)
Front	305/30R20	20 x 11 (alloy) 20 x 11 (carbon fiber)
Rear	315/30R20	20 x 11 (alloy) 20 x 11.5 (carbon fiber)

Wheels and Tires

To make sure that your tires perform as intended, it is important that you maintain your tires properly:

- Your original equipment tires are optimized for performance in both wet and dry conditions. We do not recommend using the original equipment tires when temperatures drop to about 45°F (7°C) or below (depending on tire wear and environmental conditions) or in snow and ice conditions.
- The tires were designed for track use and may exhibit significantly reduced tread life and increased tire noise compared to the standard equipment tires under normal driving conditions. Increasing the front camber settings beyond the factory settings may further accelerate tread wear and induce tire noise.
- For tire pressures, see the placard located on the B-pillar inside the driver door.
- Always maintain your tire pressures according to the tire information placard on the driver door jamb, using an accurate gauge.
- Tire pressures are specified cold and should be checked after the vehicle has been parked for at least three hours. Do not reduce pressure of warm tires.
- Check your tire pressure often to maintain it properly. Tire pressure can diminish over time and fluctuate with temperature.
- Do not overload your vehicle. Maximum vehicle and axle weights are listed on the tire information placard.
- Extra caution should be taken when operating the vehicle near its maximum load, including assuring proper tire pressure and reducing speeds.

- Extra caution should be taken when operating on rough roads to avoid impacts that could cause tire damage.
- In the event that you encounter an abnormally harsh impact, inspect your tires for damage.
- Inspect your tires for damage on a regular basis. If a tire is damaged, replace it immediately.
- Proper suspension alignment is critical for maximum performance and optimal tire wear. If you notice uneven tire wear, have your alignment checked.
- When replacing tires, the only way to maintain original performance is to use the original equipment tire. If a different tire is used, it should be the same size, speed rating and load rating and be replaced as a set of four. Never mix tire brands.
- Rotate tires as recommended in the tire rotation information. Your vehicle has a staggered tire configuration. Rotate the tires from side to side only, not from front to back. See your owner's manual for more information.

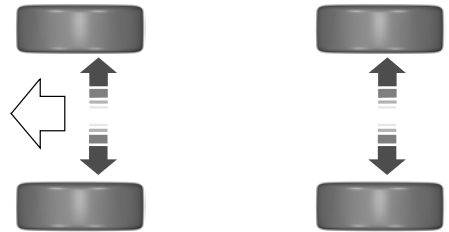

E209823

Wheels and Tires

USING WINTER TIRES

The original equipment tires on your vehicle are designed to optimize its performance in dry or wet summer road conditions. They are not optimized for off-road or winter performance and you must not use them with snow chains. The use of any type of snow chains with the original equipment wheels and tires of your vehicle may cause damage not covered by the vehicle warranty. We do not recommend using the original equipment tires when temperatures drop below 45°F (7°C) or in snow and ice conditions.

Note: *We recommend that you use winter or all-season tires when temperatures drop below 45°F (7°C) or in snow and ice conditions.*

- Use winter tires with the same load index as the summer tires originally equipped with your vehicle.
- If you fit winter tires with a speed rating less than the original equipment tires, do not exceed the maximum speed rating for the tire. Do not operate your vehicle above posted speed limits while using winter tires. Never perform high speed driving with winter tires.

Please call the Ford Performance Information Center at 1-800-367-3788 for specific winter tire recommendations.

Capacities and Specifications

ENGINE SPECIFICATIONS

Item	Description
Configuration.	90 degree V8.
Bore x stroke.	3.70 in (94 mm) bore x 3.66 in (93 mm) stroke.
Displacement.	315 in ³ (5,163 cm ³)
Compression ratio.	9.5:1
Spark plug gap.	0.037 ± 0.002 in (0.95 ± 0.05 mm)
Horsepower.	760 hp (567 kW) @ 7300 RPM
Torque.	625 lb.ft (847 Nm) @ 5000 RPM
Redline.	7500 RPM
Top speed.	180 mph (290 km/h)
Valvetrain.	Overhead cams - roller finger followers.
Ignition.	Coil on plug.
Throttle body.	3.6 in (92 mm)
Pistons.	Forged aluminum.
Crankshaft.	Forged steel cross plane.
Connecting rods.	Forged steel I-beam.
Induction.	Intercooled supercharger.
Exhaust system.	High flow dual exhaust with X-pipe and dual mode mufflers.

Capacities and Specifications

Drivebelt Routing

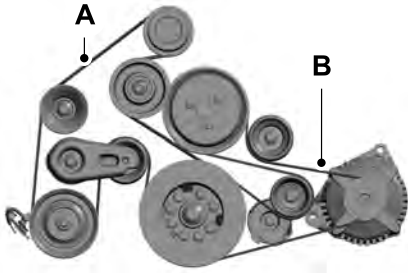

- A. Supercharger drive belt - longer drive belt on inner sheave closest to the engine. 8 ribbed belt.
- B. Alternator drive belt - shorter drive belt on outer sheave farthest from the engine. 4 ribbed belt.

BRAKE SYSTEM SPECIFICATIONS

Front

Description	Specification
Rotor diameter.	16.5 in (420 mm)
Rotor width.	1.6 in (40 mm)
Rotor swept area.	147.5 in ² (951.7 cm ²)
Caliper piston sizes.	1.3 in (34 mm)
	1.5 in (38 mm)
	1.6 in (40 mm)

Rear

Description	Specification
Rotor diameter.	14.6 in (370 mm)
Rotor width.	1.2 in (30 mm)
Rotor swept area.	95.9 in ² (619 cm ²)
Caliper piston sizes.	1.2 in (30 mm)
	1.3 in (32 mm)

Capacities and Specifications

SUSPENSION SPECIFICATIONS

Item	GT500	GT500 Carbon Fiber Track Pack
Front suspension.	MacPherson strut, double ball-joint	MacPherson strut, double ball-joint
Rear suspension.	Multi-link	Multi-link
Front spring rate.	44 N/mm (251 lbf/in)	47 N/mm (268 lbf/in)
Rear spring rate.	155 N/mm (885 lbf/in)	165 N/mm (942 lbf/in)
Front stabilizer bar.	36mm diameter x 4.8mm wall (1.42 x 0.19 in)	36mm diameter x 4.8mm wall (1.42 x 0.19 in)
Rear stabilizer bar.	24mm diameter x 3.6mm wall (0.94 x 0.14 in)	25.4mm diameter x 4.5mm wall (1.00 x 0.18 in)

Capacities and Specifications

MOTORCRAFT PARTS

Component	5.2L engine
Air filter element.	FA-1922
Fuel filter.	FG-1152
Battery.	BXT-96R-590
Oil filter.	FL-2087
Spark plugs.	SP-581
Transmission filter.	FT-223

Note: *The use of any oil filter other than the dealer supplied oil filter could cause engine damage. Use the listed Motorcraft oil filter for maximum performance, reliability and durability.*

Capacities and Specifications

CAPACITIES AND SPECIFICATIONS

Use oil and fluid that meets the defined specification and viscosity grade.

If you do not use oil and fluid that meets the defined specification and viscosity grade, it could result in:

- Component damage not covered by the vehicle warranty.
- Longer engine cranking periods.
- Increased emission levels.

- Reduced engine performance.
- Reduced fuel economy.
- Reduced brake performance.

Air Conditioning System



WARNING: The air conditioning refrigerant system contains refrigerant under high pressure. Only qualified personnel should service the air conditioning refrigerant system. Opening the air conditioning refrigerant system can cause personal injury.

Capacities

Variant	Refrigerant	Refrigerant Oil
All.	20.99 oz (0.595 kg)	3.38 fl oz (100 ml)

Materials

Name	Specification
Motorcraft® R-134a Refrigerant (U.S.) R-134a Refrigerant / Frigorigène R-134a (Canada) YN-19 (U.S.) CYN-19-R (Canada)	WSH-M17B19-A
Motorcraft® PAG Refrigerant Compressor Oil (U.S.) Motorcraft® PAG Refrigerant Compressor Oil / Huile PAG pour compresseur frigorifique Motorcraft® (Canada) YN-12-D (U.S. & Canada)	WSH-M1C231-B

Transmission

Capacities

Variant	Quantity
All.	8.0 qt (7.6 L) ¹

¹ Approximate dry fill capacity. Actual amount could vary during fluid changes.

Capacities and Specifications

Materials

Name	Specification
GT500 Dual Clutch Transmission Fluid (U.S.) GT500 Dual Clutch Transmission Fluid / GT500 Huile boîtes embrayage double (Canada) XT-14-L (U.S. & Canada)	-

Engine Coolant

Capacities

Variant	Quantity
Engine capacity.	15.2 qt (14.4 L)
Intercooler capacity.	2.5 qt (2.4 L)

Materials

Name	Specification
Motorcraft® Orange Prediluted Antifreeze/Coolant (U.S.) Motorcraft® Orange Prediluted Antifreeze/Coolant / Antigel/liquide de refroidissement prédilué orange Motorcraft® (Canada) VC-3DIL-B (U.S.) CVC-3DIL-B (Canada)	WSS-M97B44-D2

Engine Oil

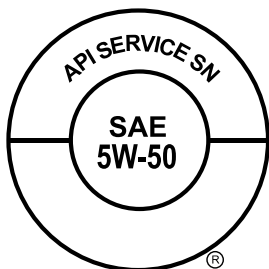

Your engine has been designed to use engine oil that meets our specification or an equivalent engine oil of the recommended viscosity grade that meets API SN requirements for gasoline engines.

Do not use supplemental engine oil additives because they are unnecessary and could lead to engine damage that your vehicle warranty does not cover.

Capacities and Specifications

Capacities

Variant	Quantity
All.	11.5 qt (10.9 L)

Materials

Name	Specification
Motorcraft® SAE 5W-50 Full Synthetic Motor Oil (U.S.) Motorcraft® SAE 5W-50 Full Synthetic Motor Oil / Huile moteur synthétique SAE 5W-50 Motorcraft® (Canada) XO-5W50-QGT (U.S. & Canada)	WSS-M2C931-C

Note: *Oil must meet specification WSS-M2C931-C or use SAE 5W-50 oil that meet API SN requirements.*

Alternative Engine Oil for Extremely Cold Climates

To improve engine cold start performance, we recommend that you use the following alternative engine oil in extremely cold climates, where the ambient temperature reaches 20°F (-7°C) or below.

Materials

Name	Specification
Engine Oil - SAE 0W-40	WSS-M2C937-A

Capacities and Specifications

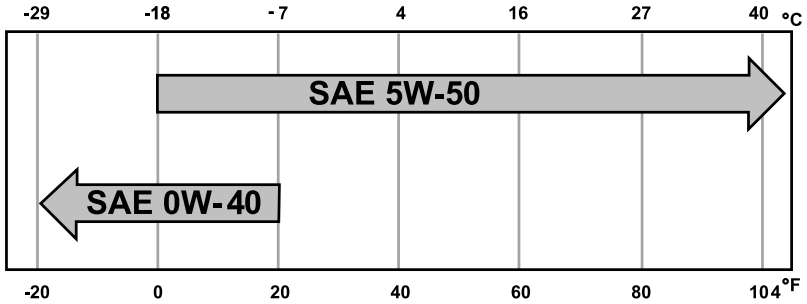

Fuel Tank

Capacities

Variant	Quantity
All.	16.0 gal (60.55 L)

Hydraulic Brake System

Use only Motorcraft DOT 4 LV High Performance Brake Fluid or equivalent meeting WSS-M6C65-A2 and ISO 4925 Class 6. Use of any fluid other than the recommended fluid could cause brake system damage. Prior to track use, replace

brake fluid with fresh Motorcraft/Ford DOT 4 LV High Performance Brake Fluid or other DOT compliant fluid with a dry boiling point greater than 500°F (260°C) from a sealed container. Do not use silicone or DOT 5 brake fluids.

Materials

Name	Specification
Motorcraft® DOT 4 LV High Performance Motor Vehicle Brake Fluid (U.S.) Motorcraft® DOT 4 LV High Performance Motor Vehicle Brake Fluid / Liquide de frein automobile haute performance DOT 4 LV Motorcraft® (Canada) PM-20 (U.S. & Canada)	WSS-M6C65-A2

Capacities and Specifications

Rear Axle

Capacities

Variant	Quantity
All	2.0 qt (1.9 L) ¹

¹ For complete refill of our limited slip axles, add 4.22 fl oz (125 ml) of Additive Friction Modifier XL-3 or equivalent meeting specification EST-M2C118-A. Include this friction modifier in the total fluid capacity. Our rear axles contain a synthetic lubricant that does not require changing unless you submerge the axle in water.

Materials

Name	Specification
Motorcraft® SAE 75W-85 Premium Synthetic Hypoid Gear Lubricant (U.S.) Motorcraft® SAE 75W-85 Premium Synthetic Hypoid Gear Lubricant / Huile synthétique de haute qualité pour engrenages hypoides SAE 75W-85 Motorcraft® (Canada) XY-75W85-QL (U.S. & Canada)	WSS-M2C942-A
Motorcraft® Additive Friction Modifier (U.S.) Motorcraft® Additive Friction Modifier / Additif modificateur de friction Motorcraft® (Canada) XL-3 (U.S.) CXL-3 (Canada)	EST-M2C118-A

Warranty Terms and Conditions

BASE WARRANTY

The GT500 carries the same warranty as other Ford Mustang models. This information is covered in its entirety in the warranty information.

Warranty service for the GT500 or any Ford Performance vehicle can be obtained at any Ford dealer nationwide.

We do not recommend modifying or racing (for competition or time) Ford Performance vehicles, as they are designed and built to be driven as delivered from the factory. The warranty information discusses vehicle usage and the installation of aftermarket parts and their effect on warranty coverage.

Additionally, perform multi-point inspection and the maintenance outlined in the 150000 mile (240000 kilometer) normal maintenance schedule of the scheduled maintenance before and after track use. See the vehicle service manual for removal and installation procedures. Replace with Genuine Ford and Motorcraft® service parts as needed.

Subjecting your vehicle to competition conditions may render repairs non-reimbursable under the warranty.

What is Not Covered Under the New Vehicle Limited Warranty?

Damage caused by:

- Abuse, competition, racing, track use or other events.
- Accidents, collision or objects striking the vehicle (including driving through a car wash).
- Theft, vandalism or riot.
- Fire or explosion.
- Using contaminated or improper fuel/fluids.
- Customer-applied chemicals or accidental spills.
- Driving through water deep enough to cause water to be ingested into any component, for example powertrain components.
- Misuse of the vehicle, such as driving over curbs, overloading or using the vehicle as a permanent stationary power source.

Scheduled Maintenance

GENERAL MAINTENANCE INFORMATION

Why Maintain Your Vehicle?

Carefully following the maintenance schedule helps protect against major repair expenses resulting from neglect or inadequate maintenance and may help to increase the value of your vehicle when you sell or trade it. Keep all receipts for completed maintenance with your vehicle.

We have established regular maintenance intervals for your vehicle based upon rigorous testing. It is important that you have your vehicle serviced at the proper times. These intervals serve two purposes; one is to maintain the reliability of your vehicle and the second is to keep your cost of owning your vehicle down.

It is your responsibility to have all scheduled maintenance performed and to make sure that the materials used meet the specifications identified in this owner's manual. See **Capacities and Specifications** (page 61).

Failure to perform scheduled maintenance invalidates warranty coverage on parts affected by the lack of maintenance.

Why Maintain Your Vehicle at Your Dealership?

Factory-Trained Technicians

Service technicians participate in extensive factory-sponsored certification training to help them become experts on the operation of your vehicle. Ask your dealership about the training and certification their technicians have received.

Genuine Ford and Motorcraft® Replacement Parts

Dealerships stock Ford, Motorcraft and Ford-authorized branded re-manufactured replacement parts. These parts meet or exceed our specifications. Parts installed at your dealership carry a nationwide 24-month or unlimited mile (kilometer) parts and labor limited warranty.

If you do not use Ford authorized parts they may not meet our specifications and depending on the part, it could affect emissions compliance.

Convenience

Many dealerships have extended evening and Saturday hours to make your service visit more convenient and they offer one stop shopping. They can perform any services that are required on your vehicle, from general maintenance to collision repairs.

Note: *Not all dealers have extended hours or body shops. Please contact your dealer for details.*

Protecting Your Investment

Maintenance is an investment that pays dividends in the form of improved reliability, durability and resale value. To maintain the proper performance of your vehicle and its emission control systems, make sure you have scheduled maintenance performed at the designated intervals.

Your vehicle is equipped with an intelligent oil-life monitor that determines oil life based on engine operating conditions.

Scheduled Maintenance

- Under normal operating conditions, a message appears in the information display to indicate the regular oil change interval.
- Under severe operating conditions, the oil change intervals reduce, and the message interval adjusts accordingly.

You can drive high performance vehicles in such a way that may lead to higher oil consumption (this includes extended time at high engine speeds, high loads, engine braking, hard cornering maneuvers, and track use). Under these conditions, oil consumption of approximately 1 quart per 500 miles (1 liter per 800 km) is possible. As a result, you need to check the engine oil level at every refueling and adjust to maintain proper levels to avoid engine damage.

Note: *Oil level should not exceed the maximum mark on the indicator. See **Engine Oil Check** (page 39).*

When the oil change message appears in the information display, it is time for an oil change. Make sure you perform the oil change within two weeks or 500 mi (800 km) of the message appearing. Make sure you reset the Intelligent Oil-Life Monitor after each oil change.

If your information display resets prematurely or becomes inoperative, you should perform the oil change interval. See **Normal Scheduled Maintenance** (page 74).

Your vehicle is very sophisticated and built with multiple, complex, performance systems. Every manufacturer develops these systems using different specifications and performance features. That is why it is important to rely upon your dealership to properly diagnose and repair your vehicle.

We recommend maintenance intervals for various parts and component systems based upon engineering testing. We rely on this testing to determine the most appropriate mileage for replacement of oils and fluids to protect your vehicle at the lowest overall cost to you and recommend against maintenance schedules that deviate from the scheduled maintenance information.

We strongly recommend the use of only genuine Ford, Motorcraft or Ford-authorized re-manufactured replacement parts engineered for your vehicle.

Additives and Chemicals

This owner's manual and the workshop manual list the recommended additives and chemicals for your vehicle. We do not recommend using chemicals or additives not approved by us as part of your vehicle's normal maintenance. Please consult your warranty information.

Oils, Fluids and Flushing

In many cases, fluid discoloration is a normal operating characteristic and, by itself, does not necessarily indicate a concern or that the fluid needs to be changed. However, a qualified expert, such as the factory-trained technicians at your dealership, should inspect discolored fluids that also show signs of overheating or foreign material contamination immediately.

Make sure to change your vehicle's oils and fluids at the specified intervals or in conjunction with a repair. Flushing is a viable way to change fluid for many vehicle sub-systems during scheduled maintenance. It is critical that systems are flushed only with new fluid that is the same as that required to fill and operate the system or using a Ford-approved flushing chemical.

Scheduled Maintenance

Owner Checks and Services

maintenance checks and inspections every month or at six-month intervals.

Make sure you perform the following basic

Check Every Month
Engine oil level (normal vehicle use).
For severe use, (high engine speed and engine loads, engine braking and track use) check engine oil level every fuel fill-up.
Function of all interior and exterior lights.
Tires; for wear and proper pressure.
Windshield washer fluid level.

Check Every Six Months
Battery connections. Clean if necessary.
Body and door drain holes for obstructions. Clean if necessary.
Cooling system fluid level and coolant strength.
Door weatherstrips for wear. Lubricate if necessary.
Hinges, latches and outside locks for proper operation. Lubricate if necessary.
Parking brake for proper operation.
Safety belts and seat latches for wear and function.
Safety warning lamps (brake, ABS, airbag and safety belt) for operation.
Washer spray and wiper operation. Clean or replace blades as necessary.

Multi-Point Inspection

In order to keep your vehicle running right, it is important to have the systems on your vehicle checked regularly. This can help identify potential issues and prevent major problems. We recommend having the following multi-point inspection performed at every scheduled maintenance interval to help make sure your vehicle keeps running great.

Scheduled Maintenance

Multi-Point Inspection	
Accessory drive belt(s)	Horn operation
Battery performance	Intercooler
Engine air filter	Radiator, cooler, heater and air conditioning hoses
Exhaust system	Suspension components for leaks or damage
Exterior lamps operation	Steering and linkage
Fluid levels ¹ ; fill if necessary	Tires; for wear and proper pressure ²
For oil and fluid leaks	Windshield for cracks, chips or pits
Half-shaft dust boots	Washer spray and wiper operation
Hazard warning system operation	

¹ Brake, coolant recovery reservoir and window washer.

² If your vehicle is equipped with a temporary mobility kit, check the tire sealant expiration Use By date on the canister. Replace as needed.

Be sure to ask your dealership service advisor or technician about the multi-point vehicle inspection. It is a comprehensive way to perform a thorough inspection of your vehicle. Your checklist gives you immediate feedback on the overall condition of your vehicle.

NORMAL SCHEDULED MAINTENANCE

Intelligent Oil-Life Monitor®

Your vehicle has an Intelligent Oil-Life Monitor that determines when you should change the engine oil based on how you use your vehicle. By using several important factors in its calculations, the monitor helps reduce the cost of owning your vehicle and reduces environmental waste at the same time.

This means you do not have to remember to change the oil on a mileage-based schedule. Your vehicle lets you know when an oil change is due by displaying a message in the information display.

The following table provides examples of vehicle use and its impact on oil change intervals. It is a guideline only. Actual oil change intervals depend on several factors and generally decrease with severity of use.

Scheduled Maintenance

When to expect the OIL CHANGE REQUIRED Message	
Interval	Vehicle Use and Example
5,000 mi (8,000 km) or Annually	Normal
	Normal commuting with highway driving Normal to moderate load Flat to moderately hilly roads No extended idling
3,000 mi (4,800 km) or Annually	Severe or Extreme
	Moderate to heavy load Mountainous conditions Extended idling Extended hot or cold operation Maximum load or track use Extreme hot or cold operation High engine speed

Normal Maintenance Intervals

Note: You must use the proper replacement parts or you may void your vehicle warranty.

At Every Oil Change Interval as Indicated by the Information Display ¹
Change the engine oil and filter. ²
Rotate the tires, inspect tire wear and measure the tread depth.
Perform a multi-point inspection, recommended.
Inspect the brake pads, rotors, hoses and parking brake.
Inspect the engine cooling system strength and hoses.
Inspect the exhaust system and heat shields.
Inspect the intercooler and intercooler coolant.
Inspect the driveshaft, CV joints and boots.
Inspect the half-shaft boots.

Scheduled Maintenance

At Every Oil Change Interval as Indicated by the Information Display¹

Inspect the steering linkage, ball joints, suspension, tie-rod ends, driveshaft and U-joints. Lubricate any areas with grease fittings.

Inspect the wheels and related components for abnormal noise, wear, looseness or drag.

¹ Do not exceed one year or 10,000 mi (16,000 km) between service intervals.

² Reset the Intelligent Oil-Life Monitor after the engine oil and filter changes.

Brake Fluid Maintenance¹

Every 3 Years

Change the brake fluid.²

¹ Perform this maintenance item every 3 years. Do not exceed the designated time for the interval.

² Brake fluid servicing requires special equipment available at your authorized dealer.

Other Maintenance Items¹

Every 20,000 mi
(32,000 km)

Inspect the intercooler and the intercooler coolant.
Inspect the supercharger drive belt.
Replace the cabin air filter.
Replace the dual clutch transmission side filter and top off fluid with the dual clutch transmission fill procedure.

Every 30,000 mi
(48,000 km)

Replace the engine air filter.

Every 40,000 mi
(64,000 km)

Change the dual clutch transmission fluid and side filter.²

Every 50,000 mi
(80,400 km)

Replace the fuel filter.

At 100,000 mi
(160,000 km)

Change the engine coolant.³

Every 100,000 mi
(160,000 km)

Replace the spark plugs.

Inspect the accessory drive belt(s).⁴

Scheduled Maintenance

Other Maintenance Items ¹	
Every 150,000 mi (240,000 km)	Change the differential fluid.
	Replace the accessory drive belt(s).

¹ Perform these maintenance items within 3,000 mi (4,800 km) of the last engine oil and filter change. Do not exceed the designated distance for the interval.

² The large main dual clutch transmission filter does not need to be serviced.

³ Initial replacement at six years or 100,000 mi (160,000 km), then every three years or 50,000 mi (80,000 km).

⁴ After initial inspection, inspect every other oil change until replaced.

Track Use Maintenance Intervals

Follow these maintenance intervals for when you use your vehicle on a track or in a high speed event.

Interval	Vehicle Use and Example
One track weekend or approximately 4 hours of track use	Change the engine oil and filter
Every 500 mi (800 km)	Change the rear axle fluid ¹



¹ Change the rear axle fluid every 500 mi (800 km) or when a red message and wrench warning indicator appears in the information display stating that the axle fluid is over temperature. See **Special Operating Conditions Scheduled Maintenance** (page 77).

SPECIAL OPERATING CONDITIONS SCHEDULED MAINTENANCE

If you operate your vehicle primarily in any of the following conditions, you need to perform extra maintenance, as indicated. If you operate your vehicle **occasionally** under any of these conditions, it is not necessary to perform the extra maintenance. For specific recommendations, see your dealership service advisor or technician.

Perform the services shown in the following tables when specified or within 3,000 mi (4,800 km) of a message appearing in the information display prompting you to change your oil.

Scheduled Maintenance

- Example 1:** The message comes on at 28,751 mi (46,270 km). Perform the 30,000 mi (48,000 km) automatic transmission fluid replacement.
- Example 2:** The message has **not** come on, but the odometer reads 30,000 mi (48,000 km) (for example, the Intelligent Oil-Life Monitor was reset at 25,000 mi (40,000 km)). Perform the engine air filter replacement.

Extensive Idling or Low-speed Driving for Long Distances	
As required	Change the engine oil and filter as indicated by the information display and perform services listed in the Normal Scheduled Maintenance chart.
Inspect frequently, service as required	Replace the cabin air filter.
Every 15,000 mi (24,000 km)	Inspect the engine air filter. Replace as required.
Every 60,000 mi (96,000 km)	Replace the spark plugs.

Operating in Dusty or Sandy Conditions Such as Unpaved or Dusty Roads	
Inspect frequently, service as required	Replace the cabin air filter.
Every 15,000 mi (24,000 km)	Inspect the engine air filter. Replace as required.
Every 5,000 mi (8,000 km)	Inspect the wheels and related components for abnormal noise, wear, looseness or drag.
	Rotate the tires, inspect the tires for wear and measure the tread depth.
Every 3,000 mi (4,828 km) or six months	Change the engine oil and filter. ¹
Every 60,000 mi (96,560 km)	Change the dual clutch transmission fluid and the side filter.

¹Reset your Intelligent Oil-Life Monitor after each engine oil and filter change.

Scheduled Maintenance

Operating at High Speeds and Track Days

Your vehicle is capable of sustained high speeds and track day driving.

Before operating your vehicle at high speeds:

- Verify your tires have the correct pressures. See **Tires** (page 58).
- Inspect wheels and tires for wear and damage. Replace any damaged wheels and tires.
- Check and set lug nut torque. See **Wheels** (page 57).
- Verify fluid levels for oil, coolant, brake, and hydraulic fluid. See **Maintenance** (page 38).
- Change the oil and filter prior to use on the track.

After operating your vehicle at high speeds or track day driving, do the following:

- Set tire pressures to specification.
- Check and set the lug nut torque. See **Wheels** (page 57).
- Check all fluid levels.
- Refer to the Track Maintenance Interval Chart. See **Normal Scheduled Maintenance** (page 74).

Exceptions

There are several exceptions to the Normal Schedule:

Axle Maintenance

If the axle fluid starts to approach the maximum allowable temperature, a yellow message appears in the information display stating that the axle is over temperature and you should reduce your speed. Reducing your speed allows the axle fluid to cool down to normal operating temperatures. Unless the wrench warning indicator appears, there is no need to change the axle fluid if you receive this message.



If the axle fluid reaches or exceeds the maximum allowable temperature, a red message appears in the information display along with a wrench warning indicator. Change the rear axle fluid at the next convenient time. For example, if you are at a track it would be acceptable to change the fluid after the track event, but before any additional track events or on-road driving takes place. The wrench warning indicator turns off when you switch off your vehicle.

Change the axle fluid anytime an axle is submerged in water.

California Fuel Filter Replacement

If you register your vehicle in California, the California Air Resources Board has determined that the failure to perform this maintenance item does not nullify the emission warranty or limit recall liability before the completion of your vehicle's useful life. Ford Motor Company, however, urges you to have all recommended maintenance services performed at the specified intervals and to record all vehicle service.

Scheduled Maintenance

Hot Climate Oil Change Intervals

Vehicles operating in the Middle East or locations with similar climates using an American Petroleum Institute (API) Certified for Gasoline Engines (Certification mark) oil of SM or SN quality, the normal oil change interval is 3,000 mi (4,800 km).

If the available API SM or SN oils are not available, then the oil change interval is 1,800 mi (2,900 km).

Engine Air Filter and Cabin Air Filter Replacement

The life of the engine air filter and cabin air filter is dependent on exposure to dusty and dirty conditions. Vehicles operated in these conditions require frequent inspection and replacement of the engine air filter and cabin air filter.

SCHEDULED MAINTENANCE RECORD

After the scheduled maintenance services are performed, record the Repair Order #, Distance and Engine Hours in the boxes provided.

<input type="radio"/> Repair Order #:	<p>Dealer stamp</p>
<input type="radio"/> Distance:	
<input type="radio"/> Engine hours (optional):	
<input type="radio"/> Multi-point inspection (recommended): <input type="checkbox"/>	
<input type="radio"/> Signature:	

Scheduled Maintenance

<input type="radio"/> Repair Order #:	<p>Dealer stamp</p>
<input type="radio"/> Distance:	
<input type="radio"/> Engine hours (optional):	
<input type="radio"/> Multi-point inspection (recommended): <input type="checkbox"/>	
<input type="radio"/> Signature:	

<input type="radio"/> Repair Order #:	<p>Dealer stamp</p>
<input type="radio"/> Distance:	
<input type="radio"/> Engine hours (optional):	
<input type="radio"/> Multi-point inspection (recommended): <input type="checkbox"/>	
<input type="radio"/> Signature:	

Scheduled Maintenance

<input type="radio"/> Repair Order #:	<p>Dealer stamp</p>
<input type="radio"/> Distance:	
<input type="radio"/> Engine hours (optional):	
<input type="radio"/> Multi-point inspection (recommended): <input type="checkbox"/>	
<input type="radio"/> Signature:	

<input type="radio"/> Repair Order #:	<p>Dealer stamp</p>
<input type="radio"/> Distance:	
<input type="radio"/> Engine hours (optional):	
<input type="radio"/> Multi-point inspection (recommended): <input type="checkbox"/>	
<input type="radio"/> Signature:	

Scheduled Maintenance

<input type="radio"/> Repair Order #:	<p>Dealer stamp</p>
<input type="radio"/> Distance:	
<input type="radio"/> Engine hours (optional):	
<input type="radio"/> Multi-point inspection (recommended): <input type="checkbox"/>	
<input type="radio"/> Signature:	

<input type="radio"/> Repair Order #:	<p>Dealer stamp</p>
<input type="radio"/> Distance:	
<input type="radio"/> Engine hours (optional):	
<input type="radio"/> Multi-point inspection (recommended): <input type="checkbox"/>	
<input type="radio"/> Signature:	

Scheduled Maintenance

<input type="radio"/> Repair Order #:	Dealer stamp
<input type="radio"/> Distance:	
<input type="radio"/> Engine hours (optional):	
<input type="radio"/> Multi-point inspection (recommended): <input type="checkbox"/>	
<input type="radio"/> Signature:	

<input type="radio"/> Repair Order #:	Dealer stamp
<input type="radio"/> Distance:	
<input type="radio"/> Engine hours (optional):	
<input type="radio"/> Multi-point inspection (recommended): <input type="checkbox"/>	
<input type="radio"/> Signature:	

Scheduled Maintenance

<input type="radio"/> Repair Order #:	<p>Dealer stamp</p>
<input type="radio"/> Distance:	
<input type="radio"/> Engine hours (optional):	
<input type="radio"/> Multi-point inspection (recommended): <input type="checkbox"/>	
<input type="radio"/> Signature:	

<input type="radio"/> Repair Order #:	<p>Dealer stamp</p>
<input type="radio"/> Distance:	
<input type="radio"/> Engine hours (optional):	
<input type="radio"/> Multi-point inspection (recommended): <input type="checkbox"/>	
<input type="radio"/> Signature:	

Scheduled Maintenance

<input type="radio"/> Repair Order #:	<p>Dealer stamp</p>
<input type="radio"/> Distance:	
<input type="radio"/> Engine hours (optional):	
<input type="radio"/> Multi-point inspection (recommended): <input type="checkbox"/>	
<input type="radio"/> Signature:	

<input type="radio"/> Repair Order #:	<p>Dealer stamp</p>
<input type="radio"/> Distance:	
<input type="radio"/> Engine hours (optional):	
<input type="radio"/> Multi-point inspection (recommended): <input type="checkbox"/>	
<input type="radio"/> Signature:	

Scheduled Maintenance

<input type="radio"/> Repair Order #:	<p>Dealer stamp</p>
<input type="radio"/> Distance:	
<input type="radio"/> Engine hours (optional):	
<input type="radio"/> Multi-point inspection (recommended): <input type="checkbox"/>	
<input type="radio"/> Signature:	

<input type="radio"/> Repair Order #:	<p>Dealer stamp</p>
<input type="radio"/> Distance:	
<input type="radio"/> Engine hours (optional):	
<input type="radio"/> Multi-point inspection (recommended): <input type="checkbox"/>	
<input type="radio"/> Signature:	

Scheduled Maintenance

<input type="radio"/> Repair Order #:	<p>Dealer stamp</p>
<input type="radio"/> Distance:	
<input type="radio"/> Engine hours (optional):	
<input type="radio"/> Multi-point inspection (recommended): <input type="checkbox"/>	
<input type="radio"/> Signature:	

<input type="radio"/> Repair Order #:	<p>Dealer stamp</p>
<input type="radio"/> Distance:	
<input type="radio"/> Engine hours (optional):	
<input type="radio"/> Multi-point inspection (recommended): <input type="checkbox"/>	
<input type="radio"/> Signature:	

Scheduled Maintenance

<input type="radio"/> Repair Order #:	Dealer stamp
<input type="radio"/> Distance:	
<input type="radio"/> Engine hours (optional):	
<input type="radio"/> Multi-point inspection (recommended): <input type="checkbox"/>	
<input type="radio"/> Signature:	

<input type="radio"/> Repair Order #:	Dealer stamp
<input type="radio"/> Distance:	
<input type="radio"/> Engine hours (optional):	
<input type="radio"/> Multi-point inspection (recommended): <input type="checkbox"/>	
<input type="radio"/> Signature:	

Scheduled Maintenance

<input type="radio"/> Repair Order #:	Dealer stamp
<input type="radio"/> Distance:	
<input type="radio"/> Engine hours (optional):	
<input type="radio"/> Multi-point inspection (recommended): <input type="checkbox"/>	
<input type="radio"/> Signature:	

Index

A

About This Supplement.....	3
Ford Performance.....	4
SVT History.....	4
Team RS History.....	4
ABS	
See: Brakes.....	24
Air Filter	
See: Changing the Engine Air Filter.....	43
At a Glance.....	6
Audio Control.....	10
You can operate the following functions with the control:.....	10
Automatic Transmission.....	17
Dual Clutch Transmission Adaptive Learning.....	22
If Your Vehicle Gets Stuck In Mud or Snow.....	23
Manual Park Release.....	21
SelectShift in Manual (M).....	21
Understanding the Positions of Your Rotary Shift Transmission.....	17

B

Base Warranty.....	70
What is Not Covered Under the New Vehicle Limited Warranty?.....	70
Bonnet Lock	
See: Opening and Closing the Hood.....	38
Brakes.....	24
General Information.....	24
Brake System Specifications.....	62
Breaking-In.....	35
Cold Engine Operation.....	35
Ground Clearance.....	35

C

Capacities and Specifications.....	65
Air Conditioning System.....	65
Alternative Engine Oil for Extremely Cold Climates.....	67
Engine Coolant.....	66
Engine Oil.....	66
Fuel Tank.....	68
Hydraulic Brake System.....	68

Rear Axle.....	69
Transmission.....	65
Car Wash	
See: Cleaning the Exterior.....	56
Changing the Engine Air Filter.....	43
Changing the Engine Oil and Oil Filter.....	40
Child Safety.....	8
Cleaning the Exterior.....	56
Washing Your Vehicle (Base Vehicle).....	56
Washing Your Vehicle (Carbon Fiber Track Pack).....	56
Coolant Check	
See: Engine Coolant Check.....	41

D

Drive Control.....	27
Active Exhaust.....	29
Selectable Drive Modes.....	27
Selectable Steering and MagneRide™ Dampers.....	28
Drive Mode Control.....	11
Driving Aids.....	27
Driving Hints.....	35
Driving Through Water.....	35

E

Electric Parking Brake.....	24
Applying the Electric Parking Brake.....	25
Automatically Releasing the Electric Parking Brake.....	25
Manually Releasing the Electric Parking Brake.....	25
Releasing the Electric Parking Brake if the Vehicle Battery is Running Out of Charge.....	25
Engine Coolant Check.....	41
Adding Engine Coolant.....	41
Engine Oil Check.....	39
Engine Oil Recommendation.....	40
Engine Specifications.....	61
Drivebelt Routing.....	62
EPB	
See: Electric Parking Brake.....	24

Index

F	
Fuel and Refueling.....	16
Fuel Quality.....	16
Choosing the Right Fuel.....	16
Fuses.....	37
Fuse Specification Chart.....	37
G	
Gauges.....	12
Gearbox	
See: Transmission.....	17
General Maintenance Information.....	71
Multi-Point Inspection.....	73
Owner Checks and Services.....	73
Protecting Your Investment.....	71
Why Maintain Your Vehicle?.....	71
Why Maintain Your Vehicle at Your Dealership?.....	71
H	
Hood Lock	
See: Opening and Closing the Hood.....	38
I	
Information Display Control.....	10
Quick Action Menus.....	10
Information Displays.....	13
General Information.....	13
Installing Child Restraints.....	8
Rear Seat Delete.....	8
Instrument Cluster.....	12
Introduction.....	3
M	
Maintenance.....	38
Message Center	
See: Information Displays.....	13
Motorcraft Parts.....	64
N	
Normal Scheduled Maintenance.....	74
Intelligent Oil-Life Monitor®.....	74
Normal Maintenance Intervals.....	75
Track Use Maintenance Intervals.....	77
O	
Oil Check	
See: Engine Oil Check.....	39
Opening and Closing the Hood.....	38
Closing the Hood.....	38
Opening the Hood.....	38
R	
Roadside Emergencies.....	36
Running-In	
See: Breaking-In.....	35
S	
Scheduled Maintenance Record.....	80
Scheduled Maintenance.....	71
Special Operating Conditions Scheduled Maintenance.....	77
Exceptions.....	79
Operating at High Speeds and Track Days.....	79
Stability Control.....	26
Steering Wheel.....	10
Suspension Specifications.....	63
T	
Technical Specifications	
See: Capacities and Specifications.....	61
Tires.....	58
Tires	
See: Wheels and Tires.....	57
Towing a Trailer.....	30
Towing Points.....	36
Installing the Recovery Hook.....	36
Recovery Hook Location.....	36
Towing the Vehicle on Four Wheels.....	33
Emergency Towing.....	33
Recreational Towing (Flat Towing).....	34
Towing.....	30
Track Use.....	44
.....	44

Index

Adjustable Camber Front Strut Top	
Mounts.....	49
Brake Burnishing.....	53
Operating at High Speeds and on Track	
Days.....	44
Road Course Alignment	
Recommendations.....	47
Track Aerodynamic Components.....	49
Track Tire Pressures.....	48
Transmission.....	17
Technical Specifications.....	23
Transporting the Vehicle.....	30
Alternate Flatbed Method.....	32
Preferred Flatbed Method.....	31
Transporting or Trailering (If Equipped with Carbon Fiber Track Pack).....	32

U

Under Hood Overview.....	39
Using Stability Control.....	26
Using Winter Tires.....	60

V

Vehicle Care.....	55
General Information.....	55
Voice Control.....	10

W

Warranty Terms and Conditions.....	70
Washers	
See: Cleaning the Exterior.....	56
Wheels and Tires.....	57
Wheels.....	57
Carbon Fiber Wheels.....	57
Wheel Lug Nut Torque Specifications.....	57
Winter Tires	
See: Using Winter Tires.....	60
Wrecker Towing	
See: Transporting the Vehicle.....	30